

## Maloformátová plechová střešní krytina

**Germania**<sup>®</sup>  
simetric



  
**GERMAN**  
simetric



**TAIA**

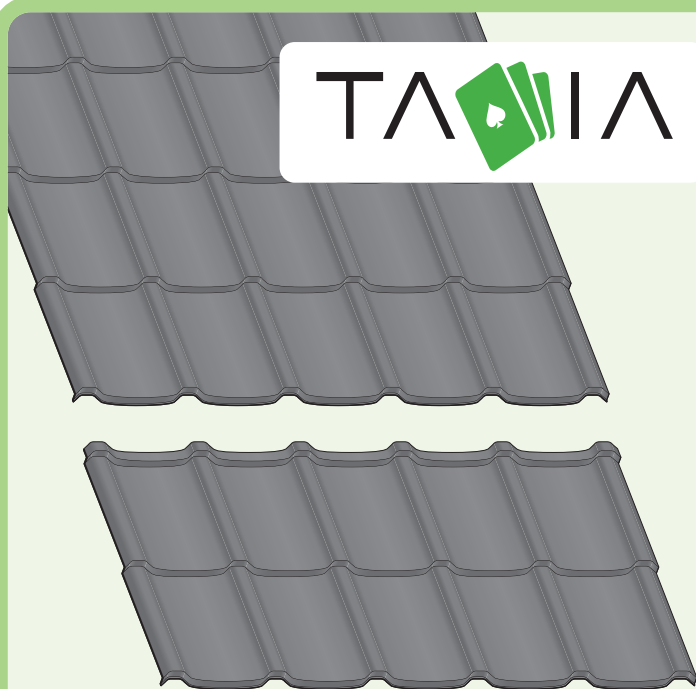

  
**ENIGMA**

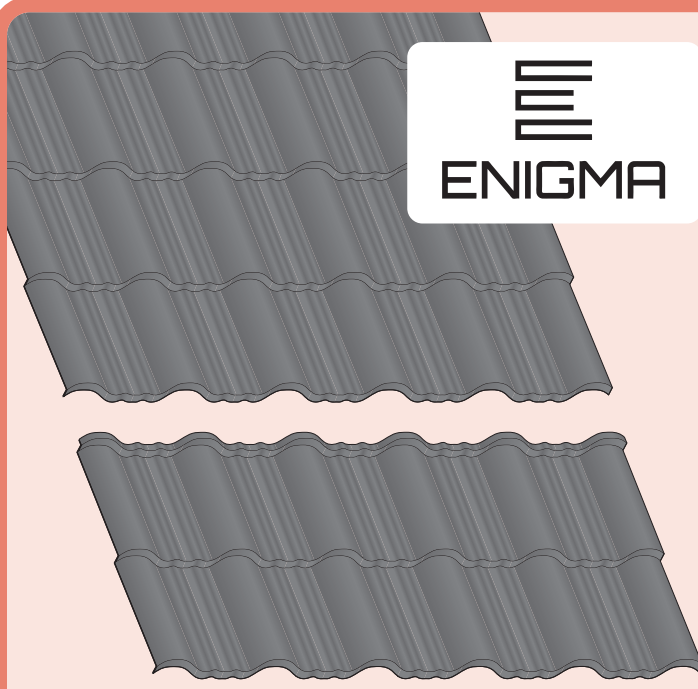

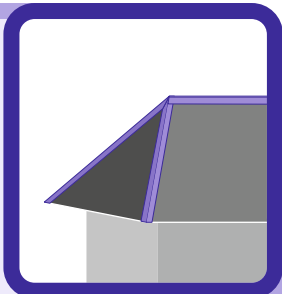
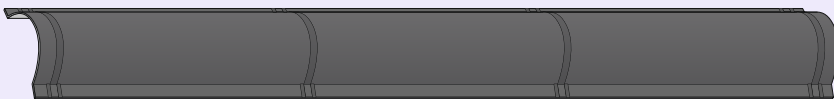
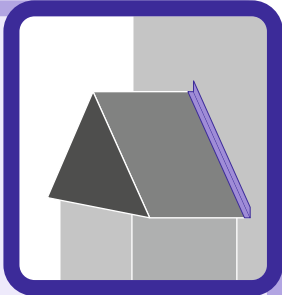
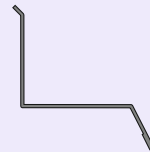
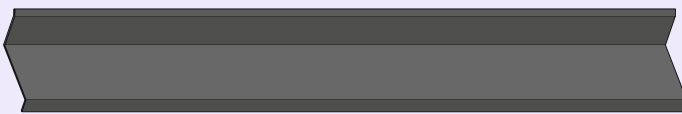
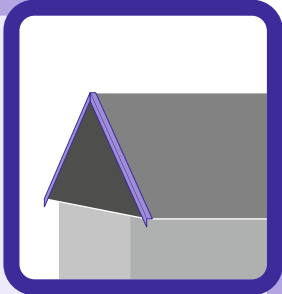
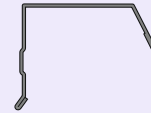
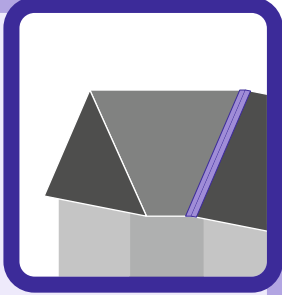
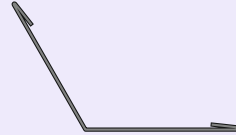
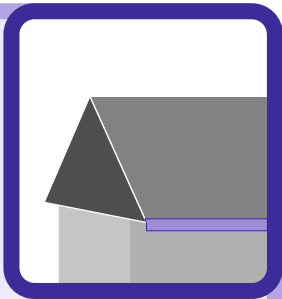

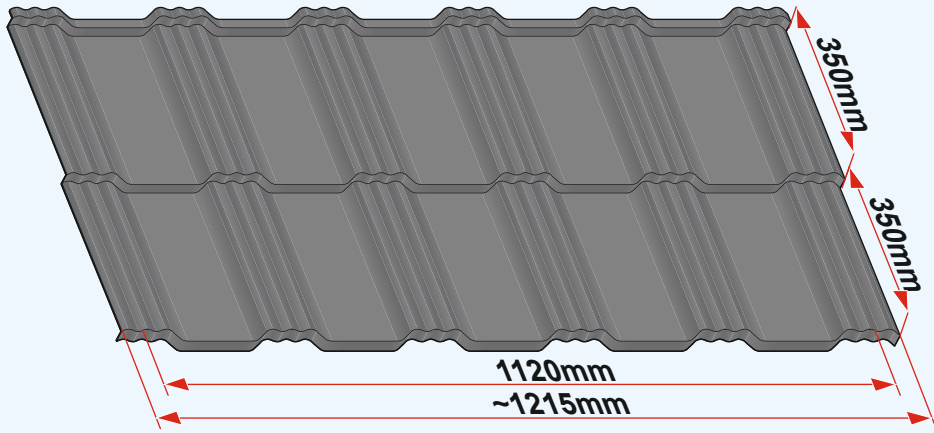

**Germania**  
simetric

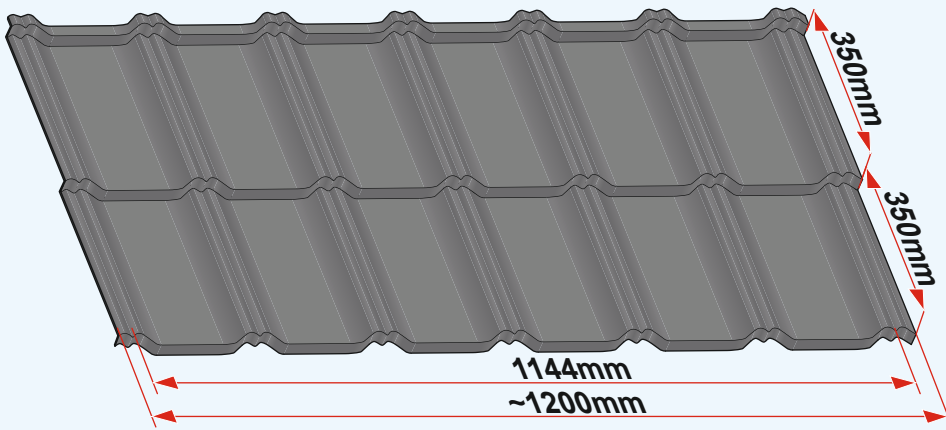
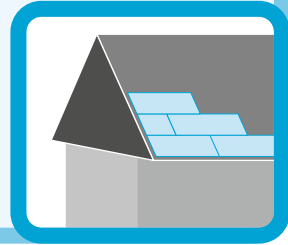

**GERMAN**  
simetric

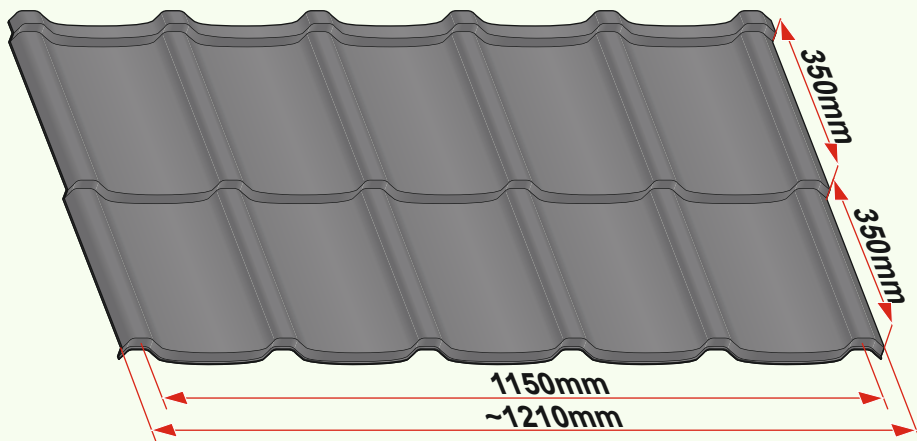
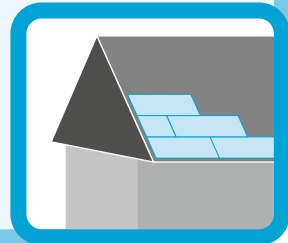

**TAIA**

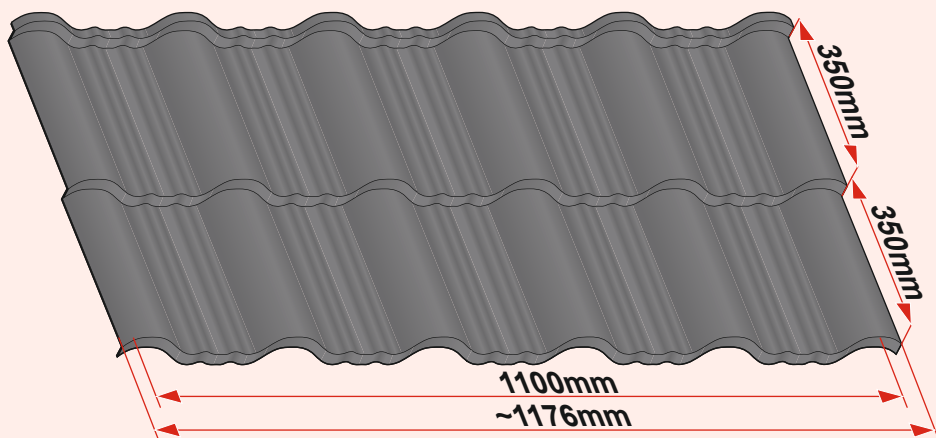
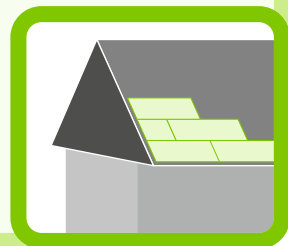

**ENIGMA**

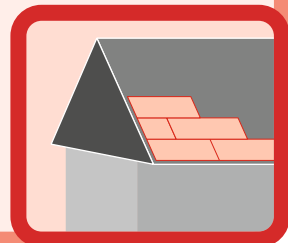

1

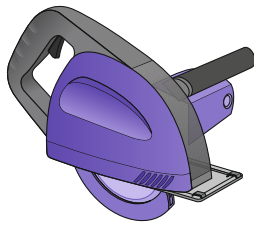

max4000r/min

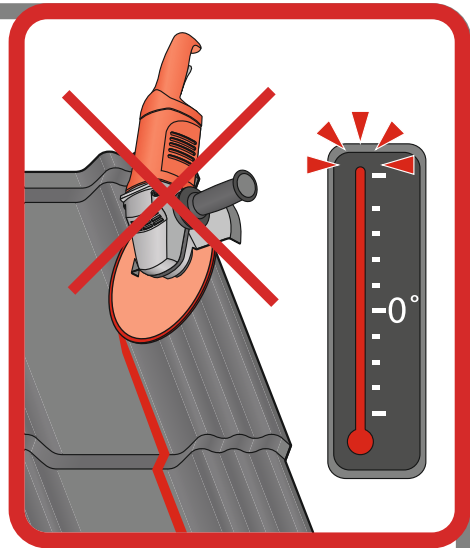
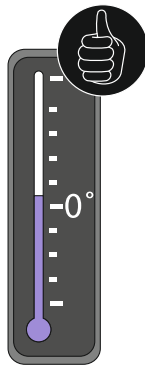
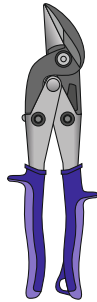
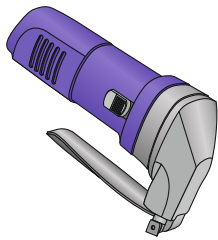

2

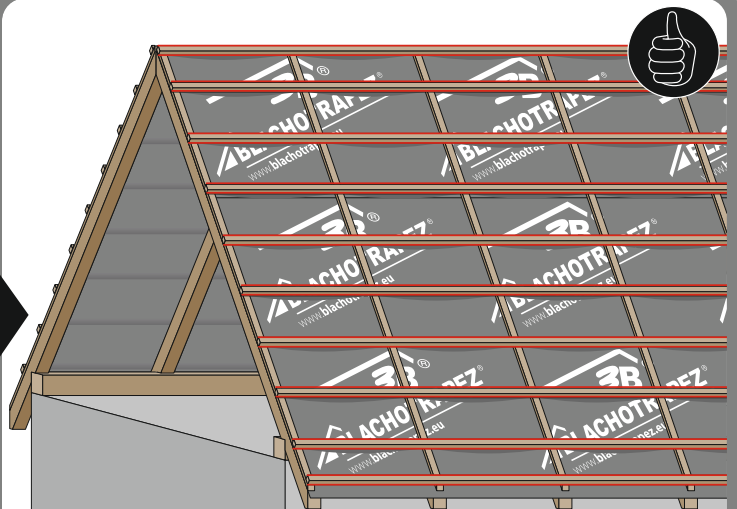
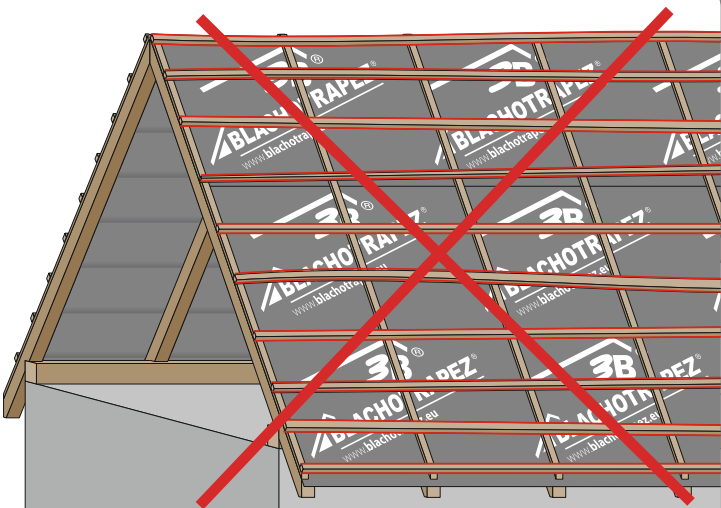
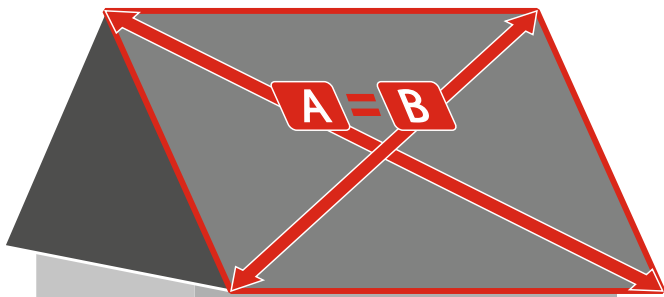

3a

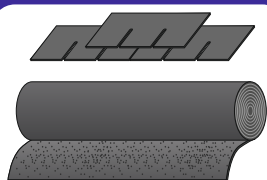
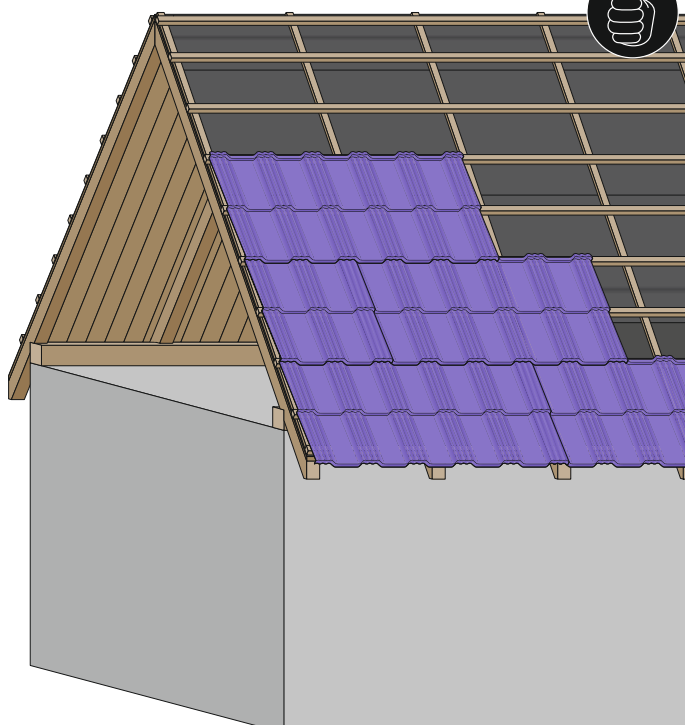
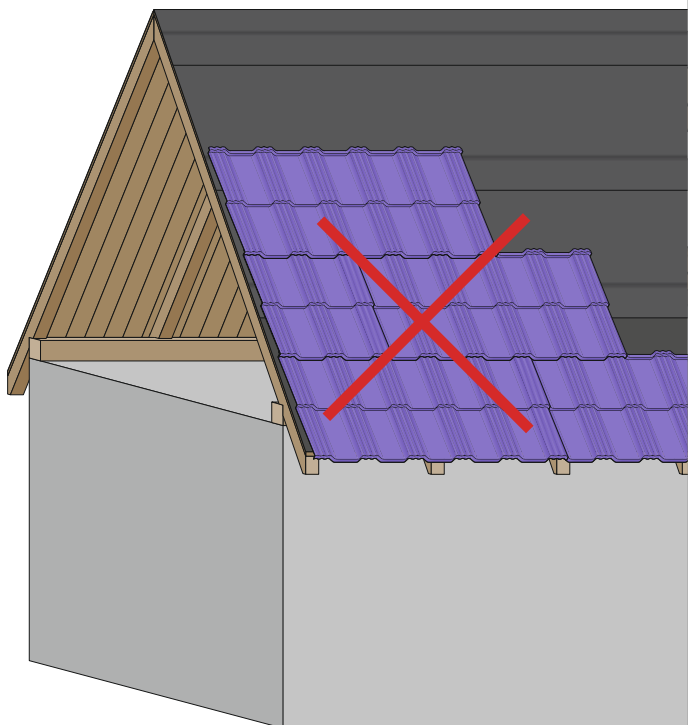
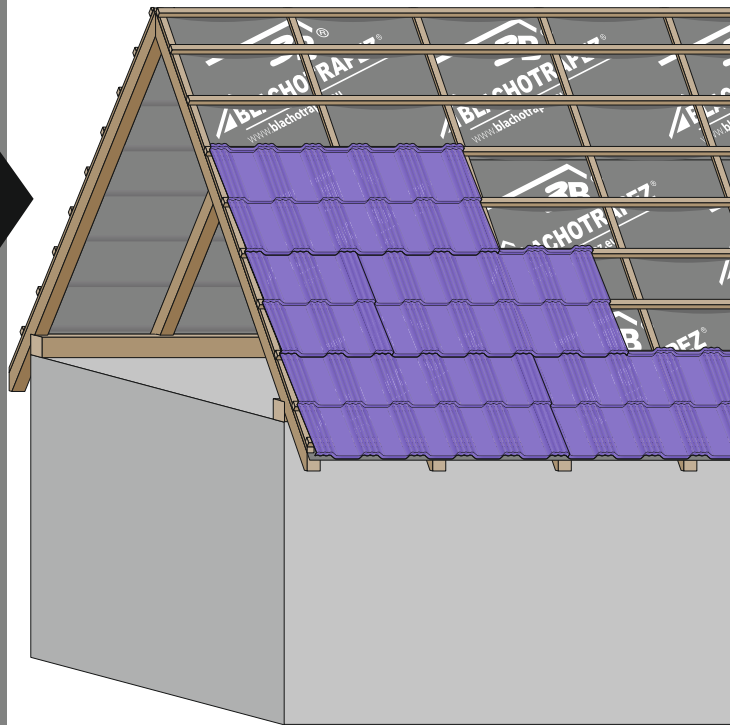
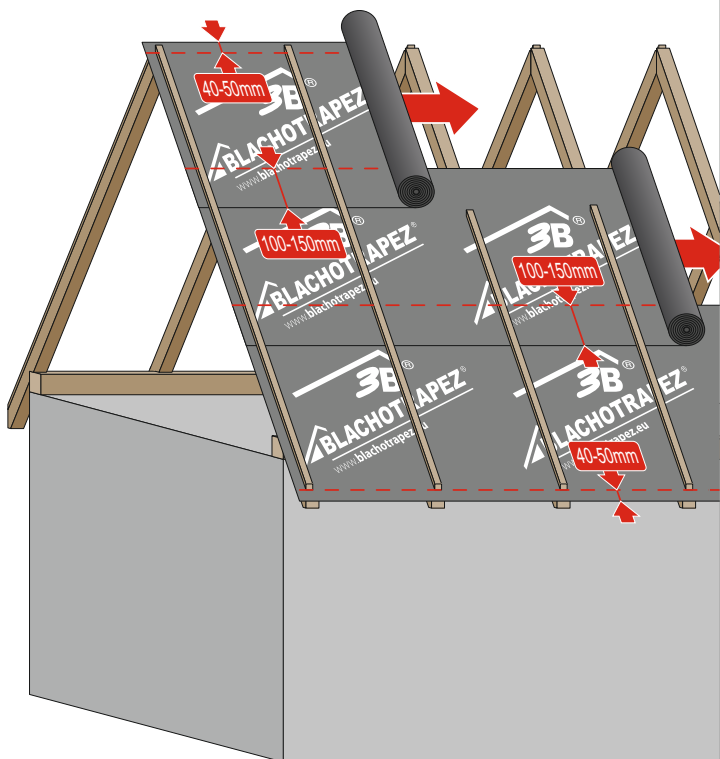

3b

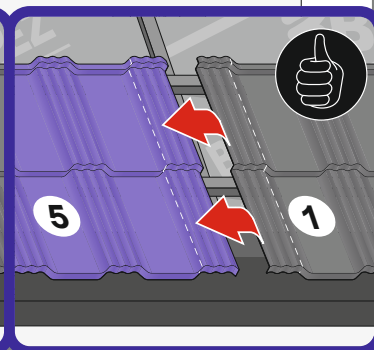
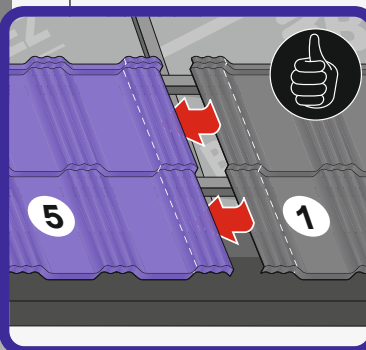
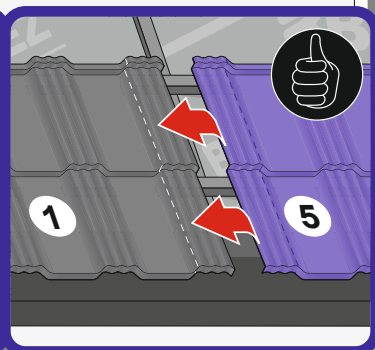
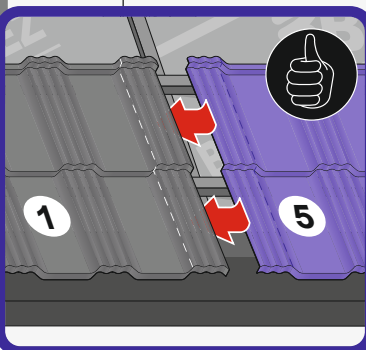
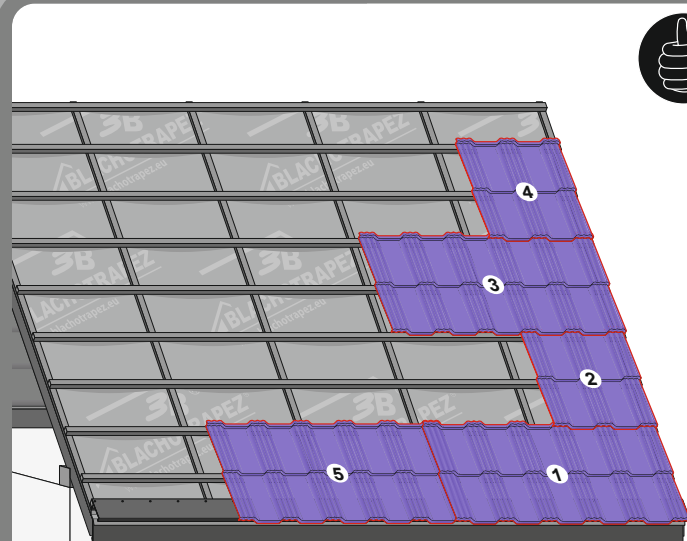
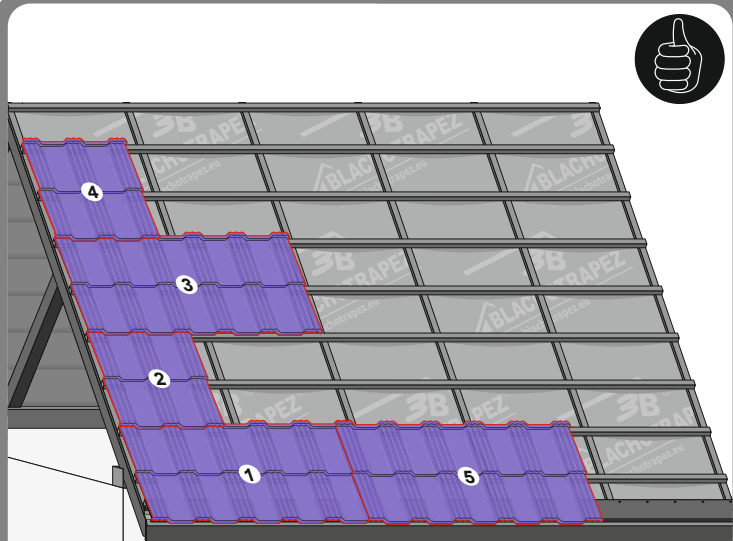
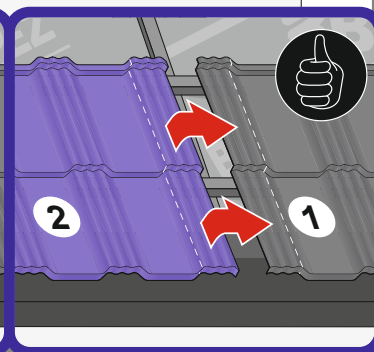
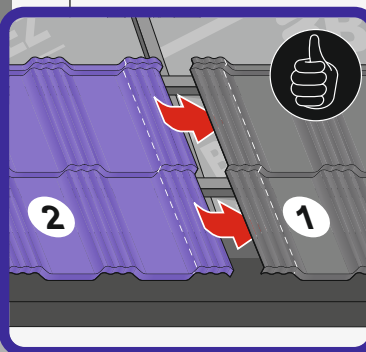
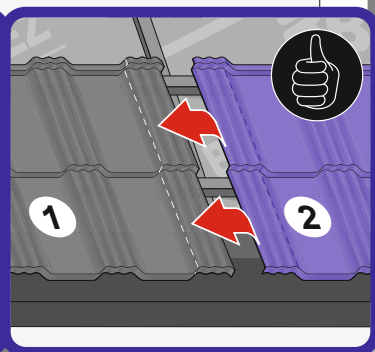
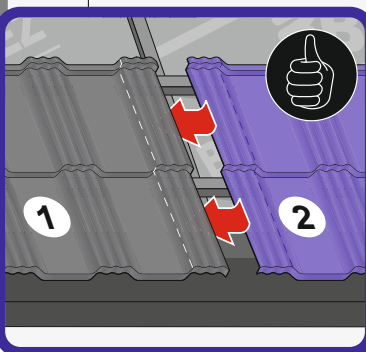
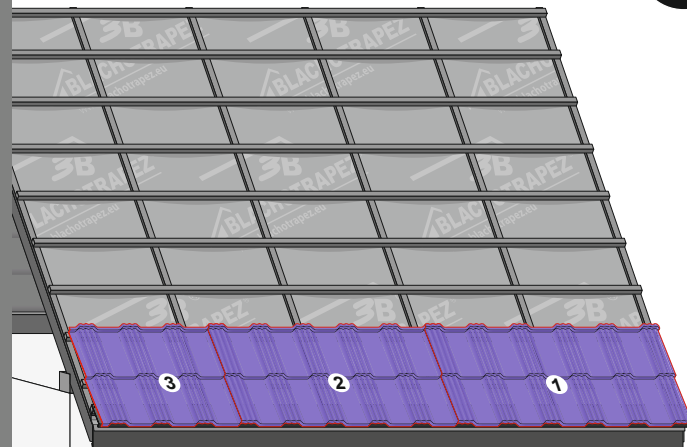
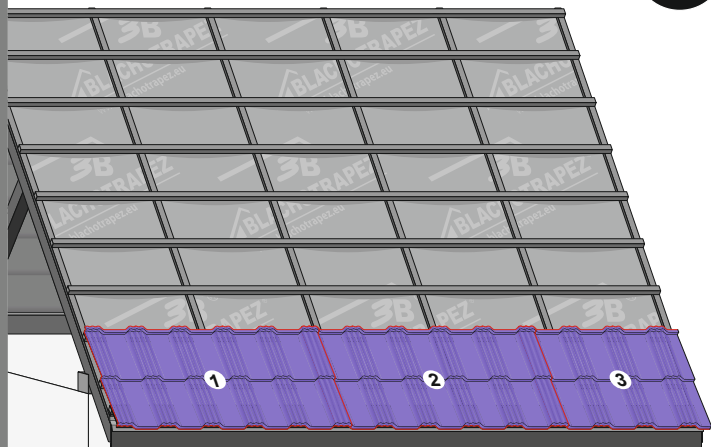

3c

**Germania**<sup>®</sup>  
simetric

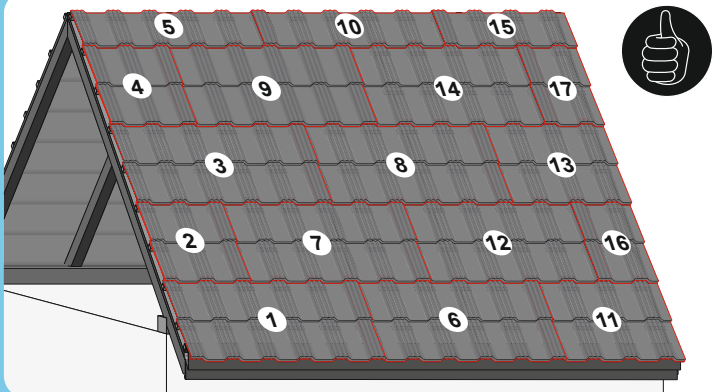
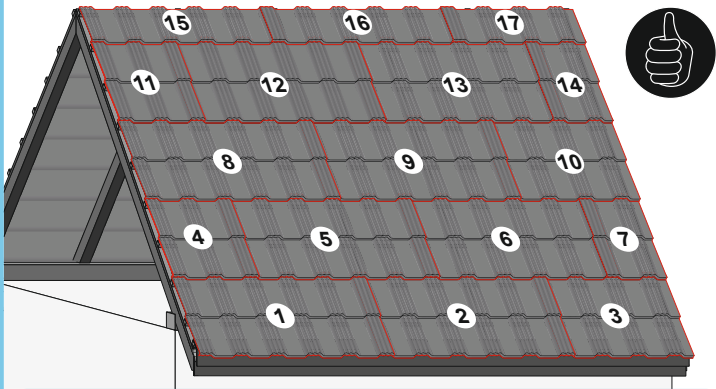

3d

  
**GERMAN**  
simetric

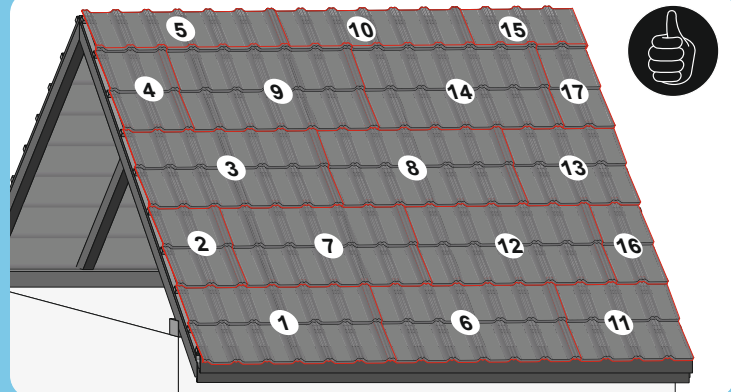
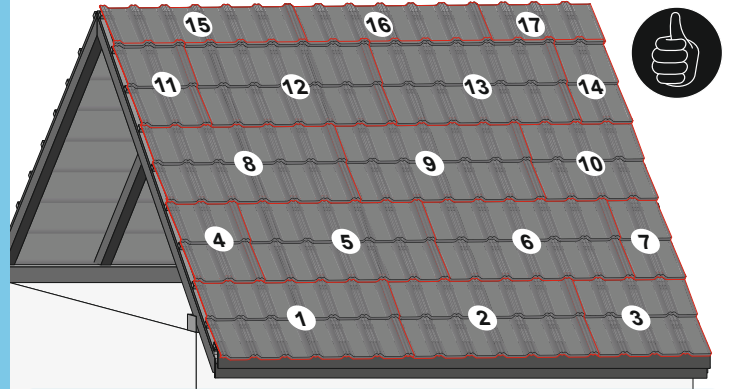

3e

**TANIA**

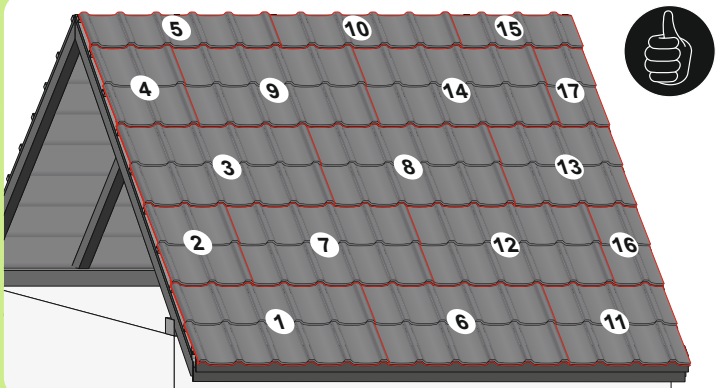
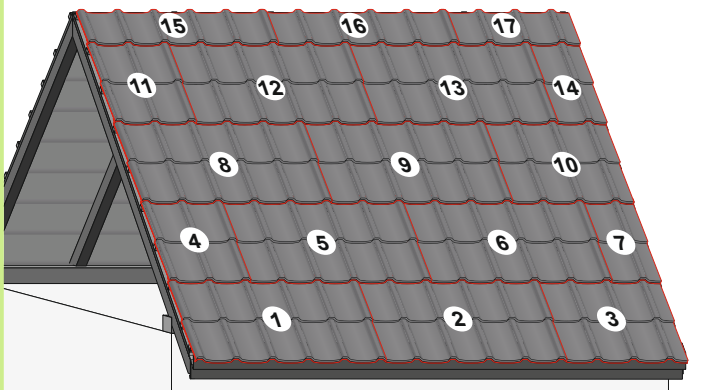

3f

  
**ENIGMA**

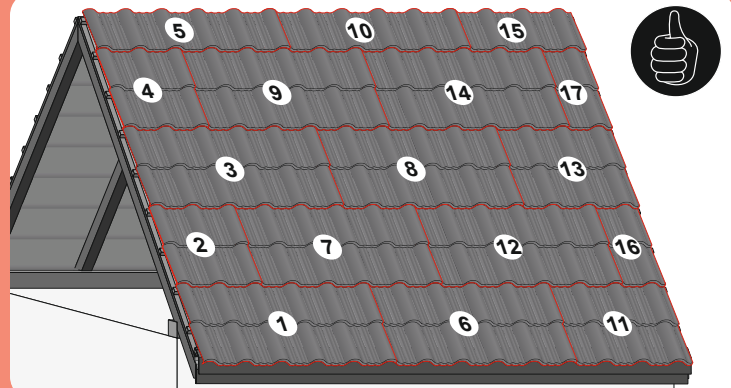
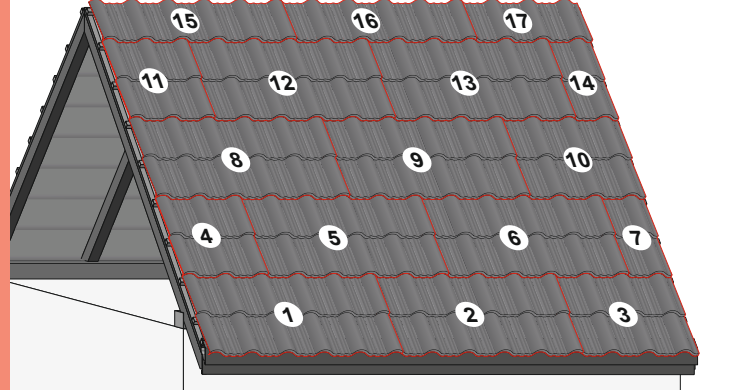

4

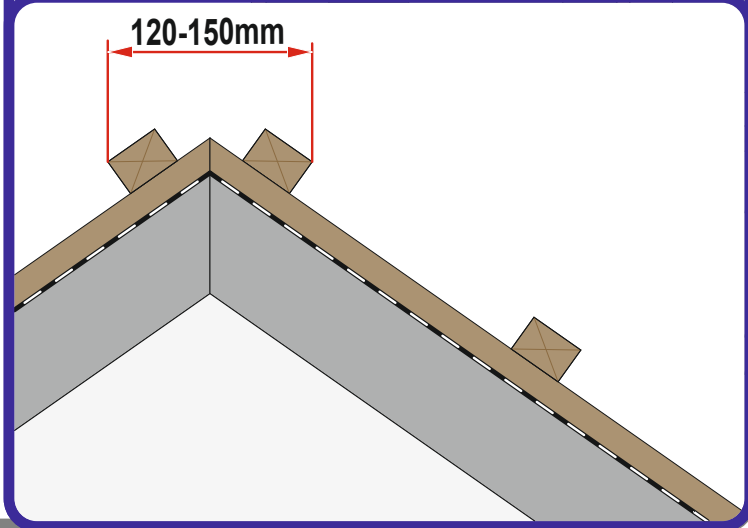
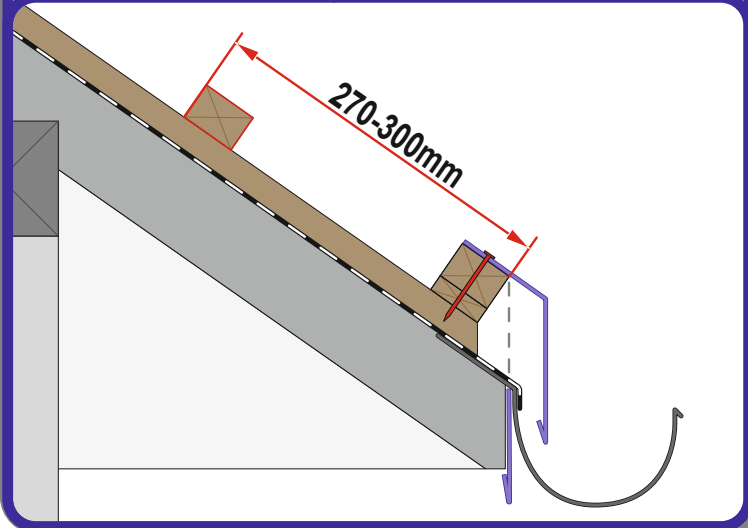
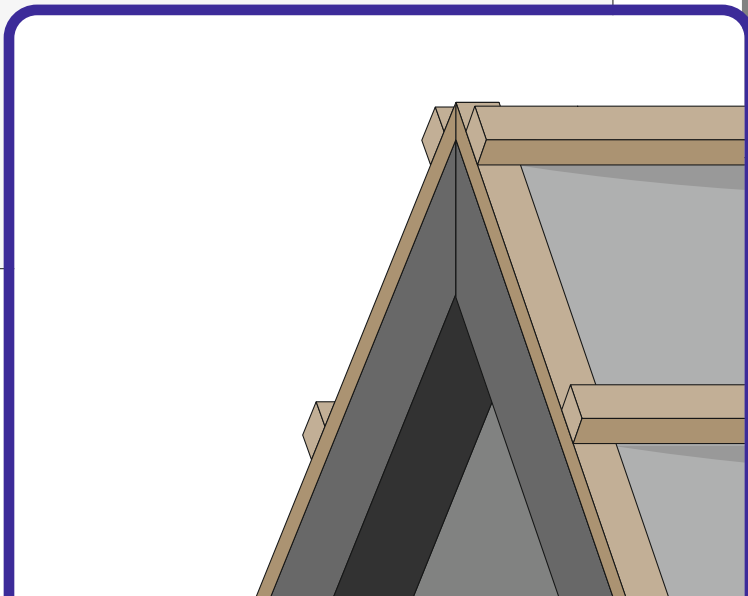
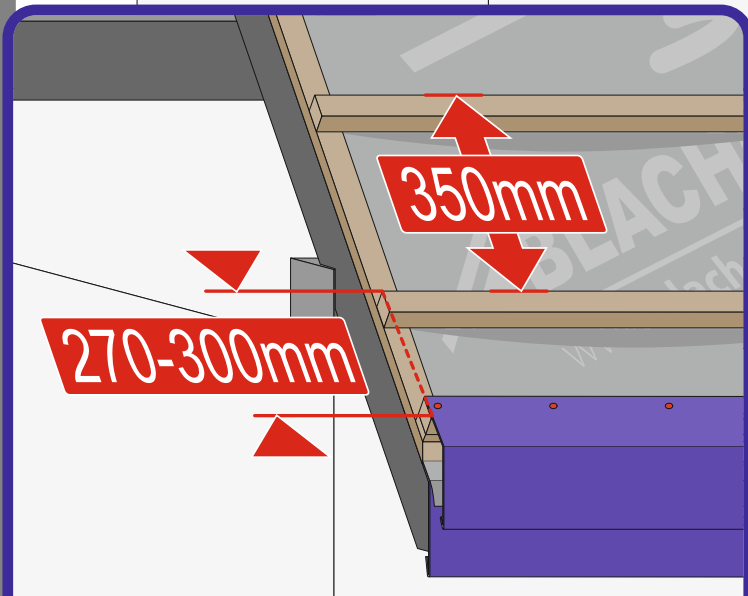
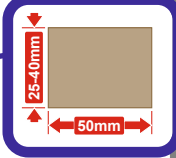
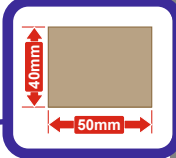
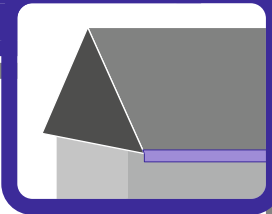
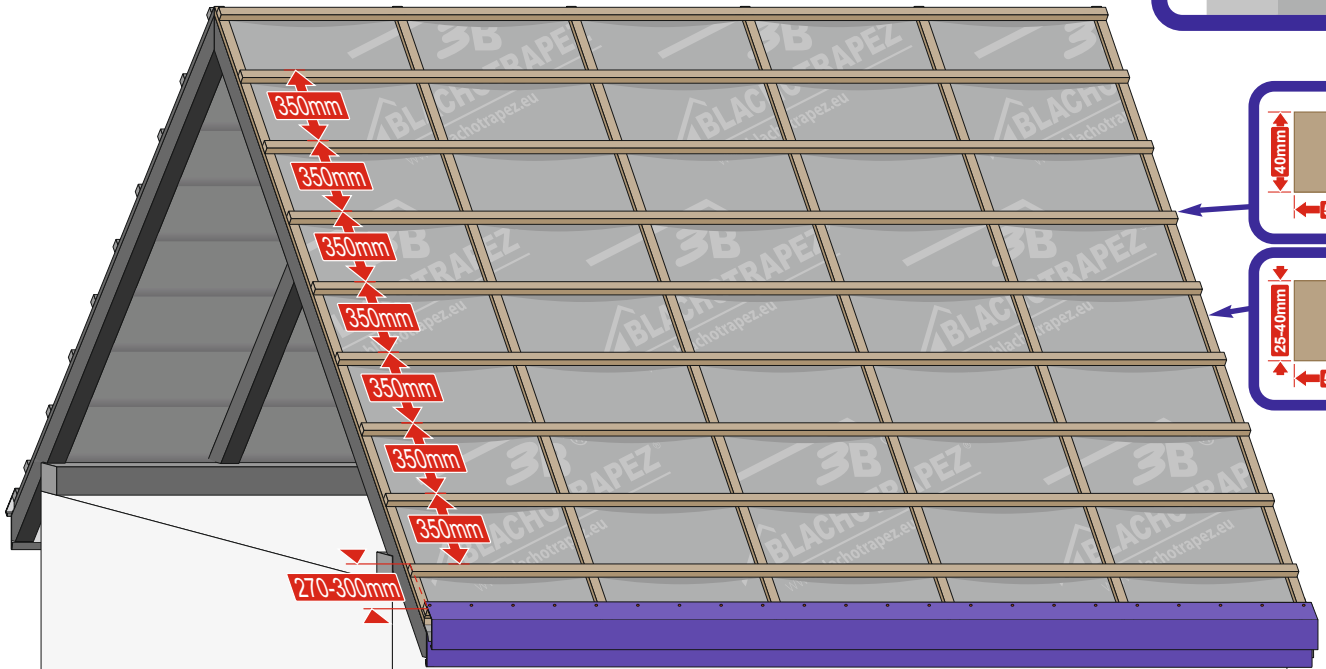



5a

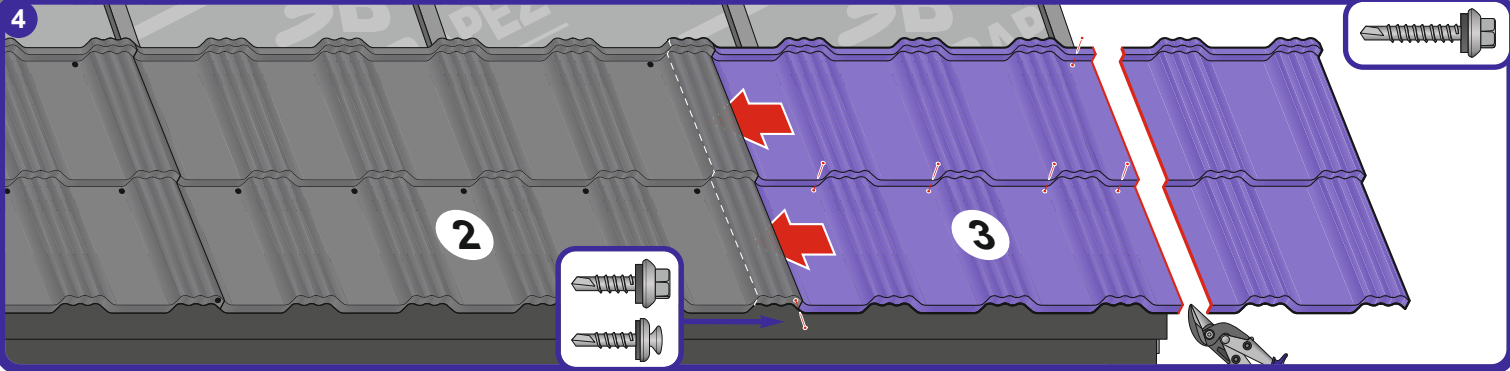
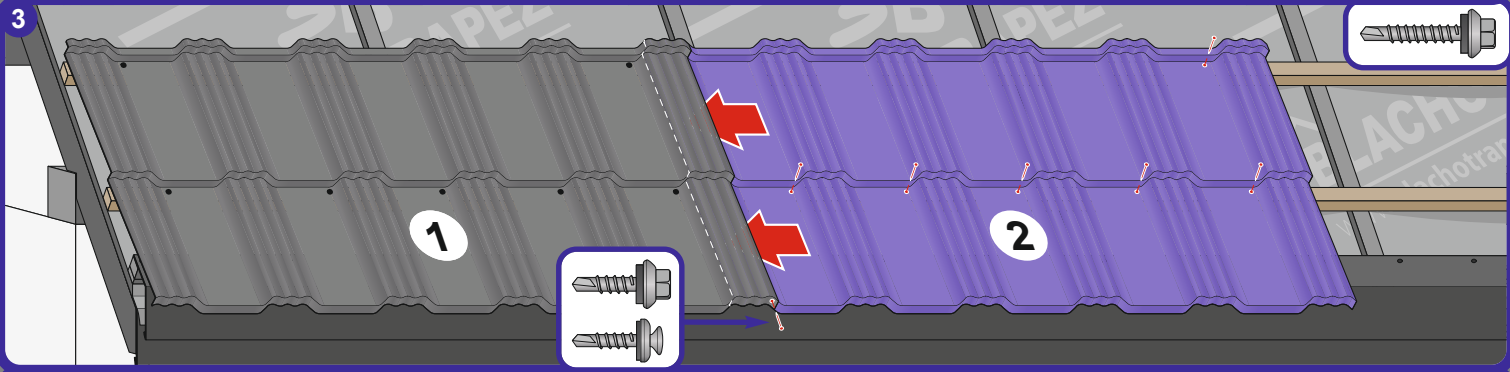
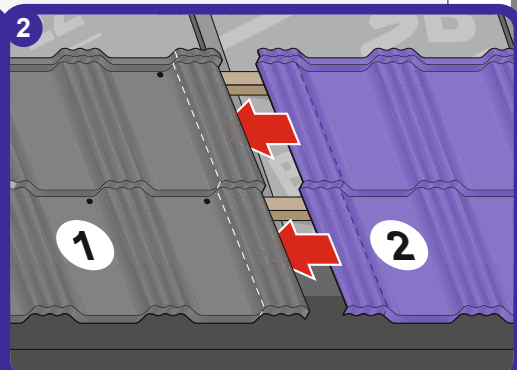
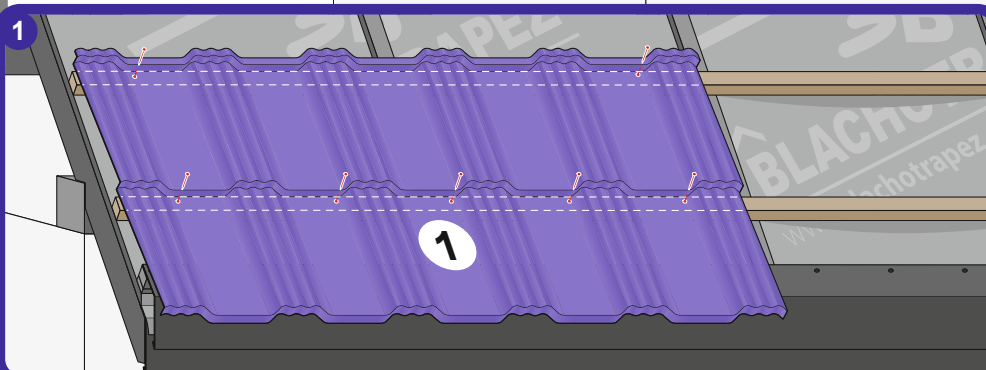
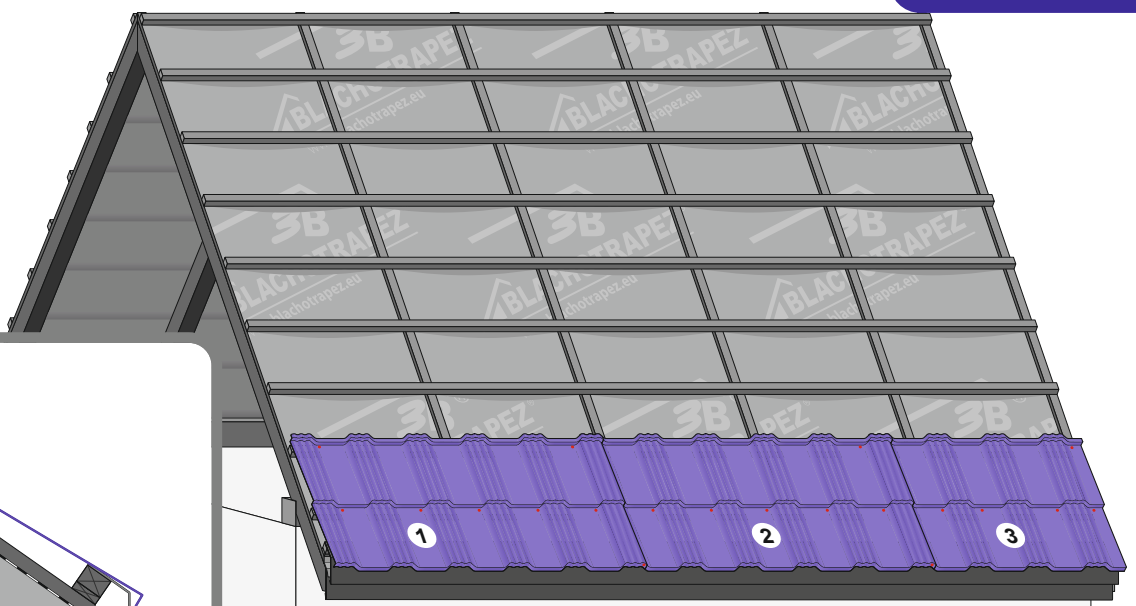
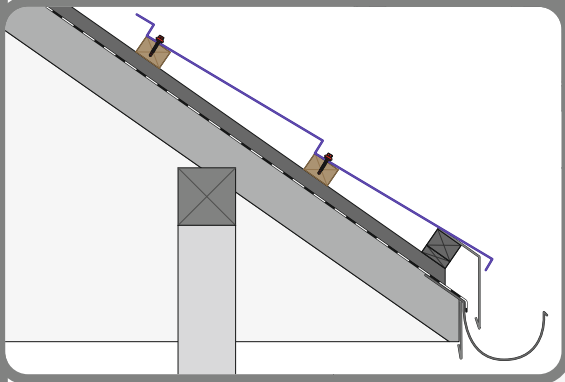
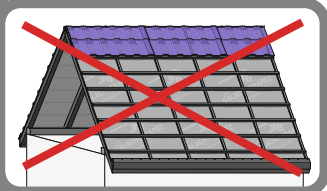
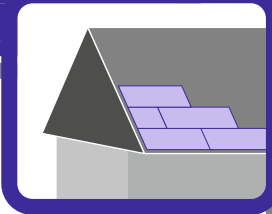

5b

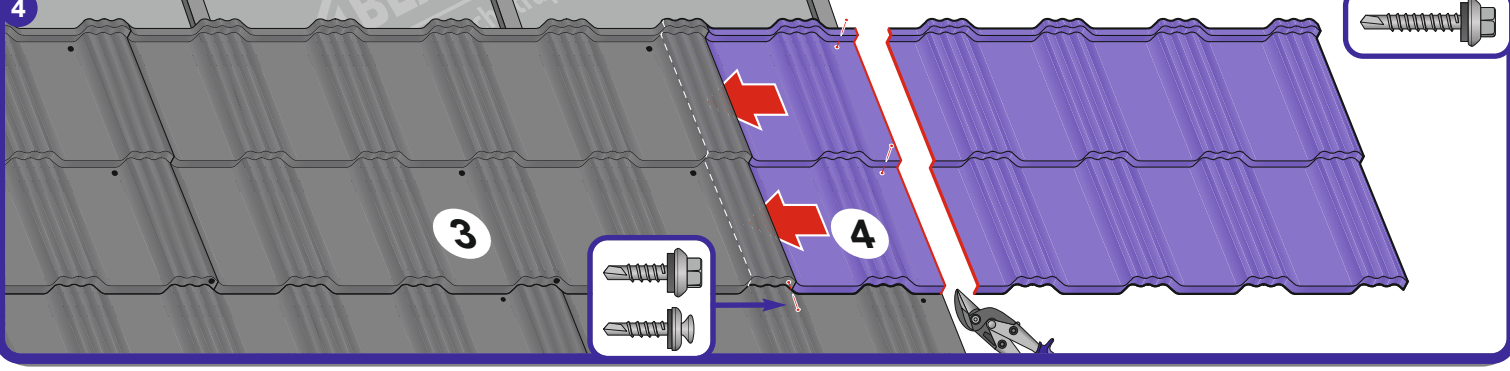
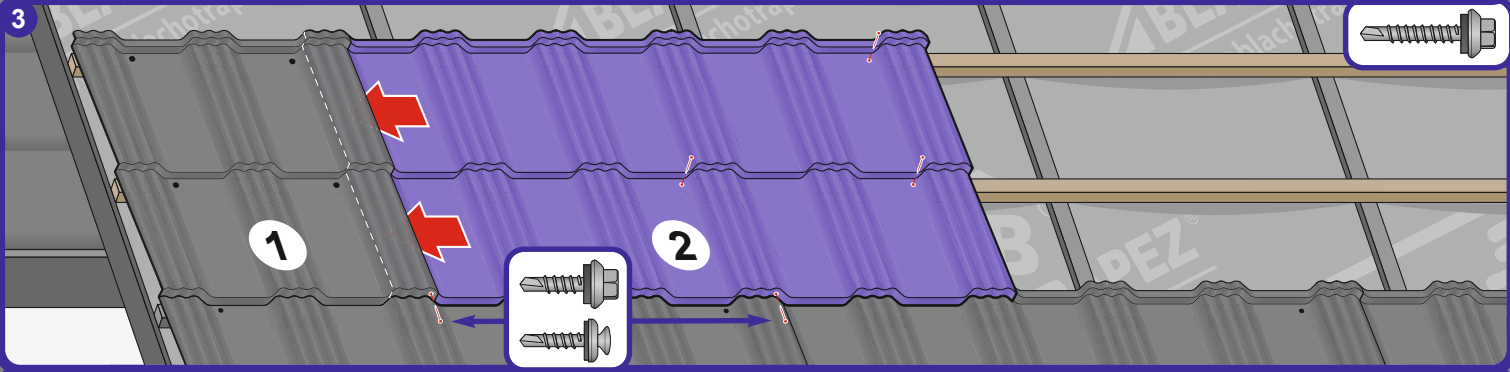
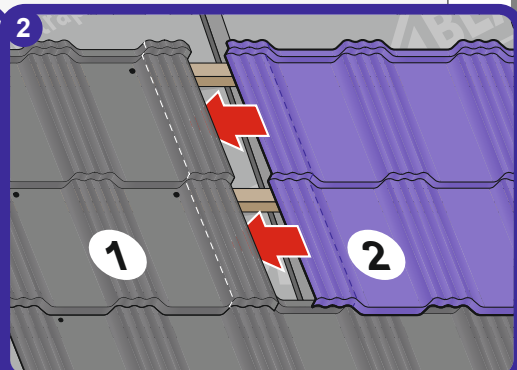
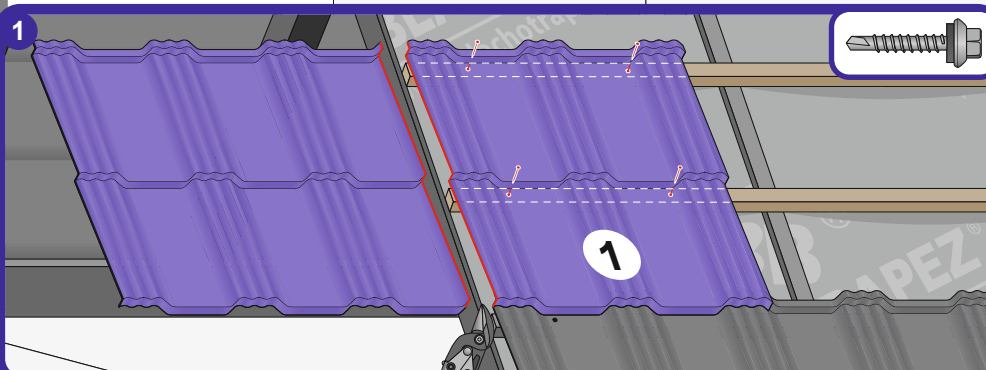
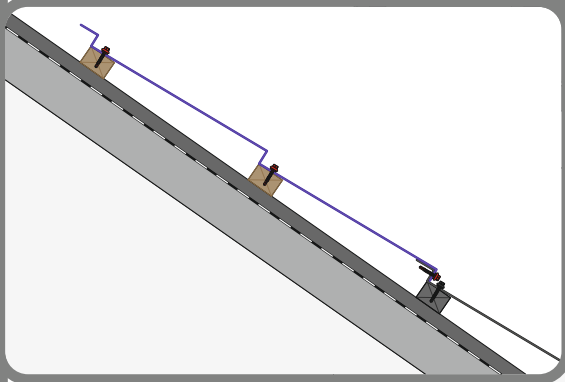
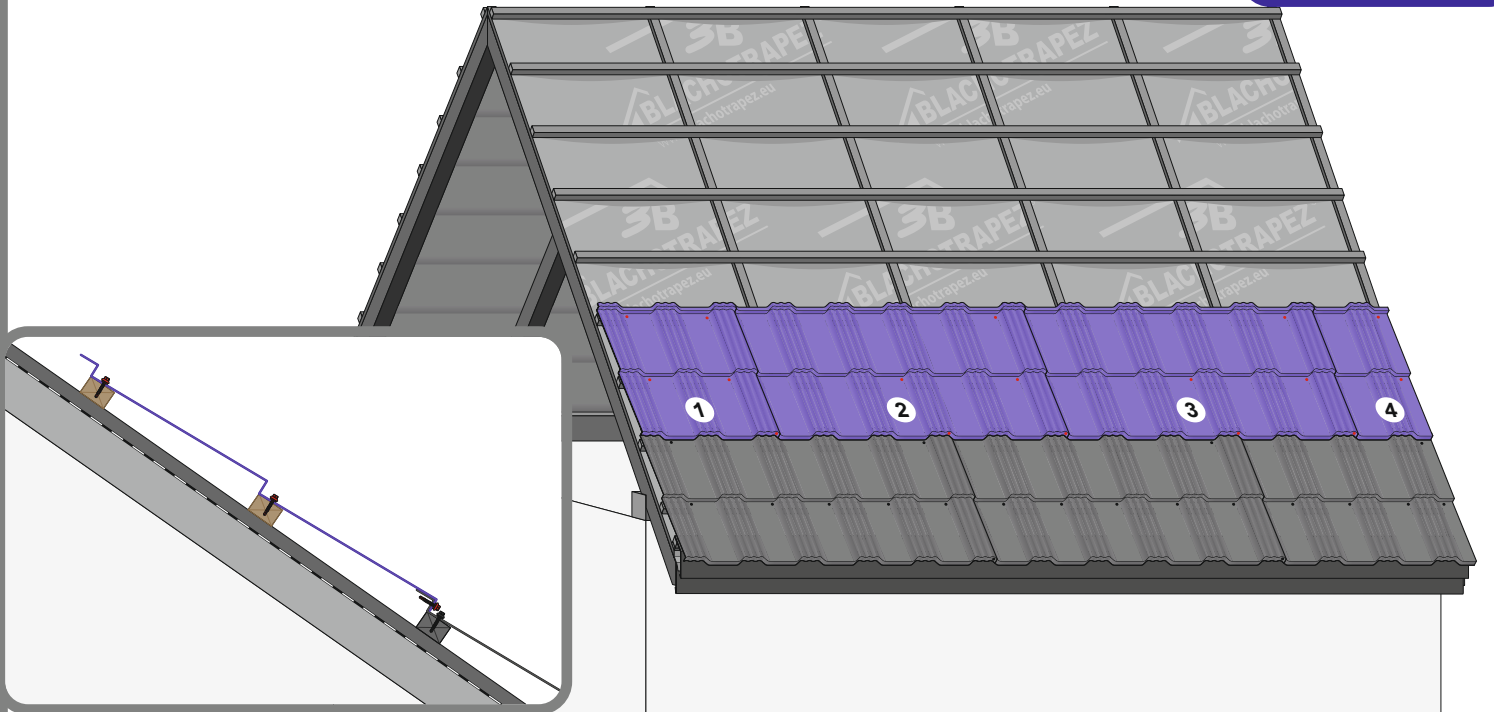
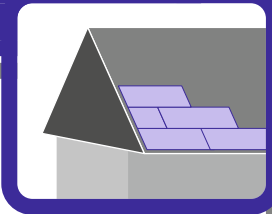

5c

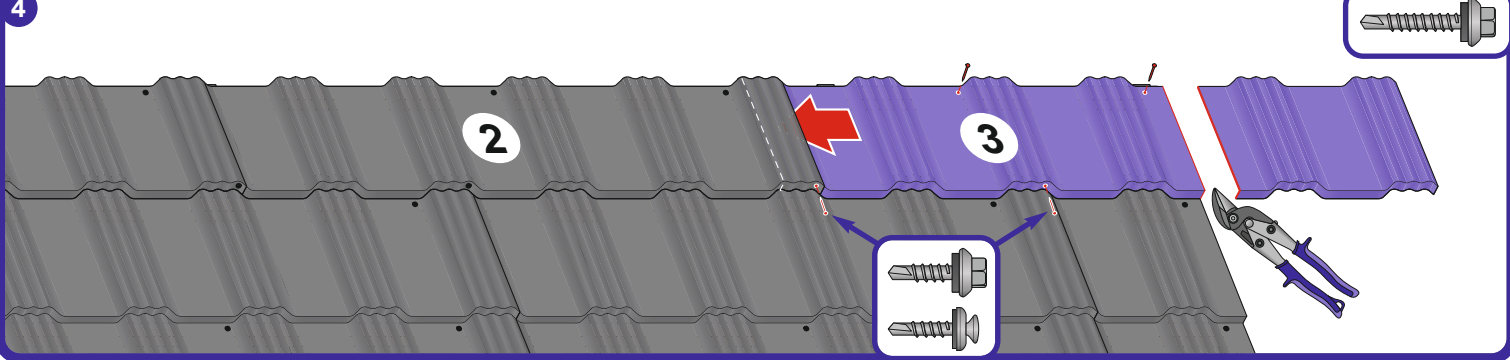
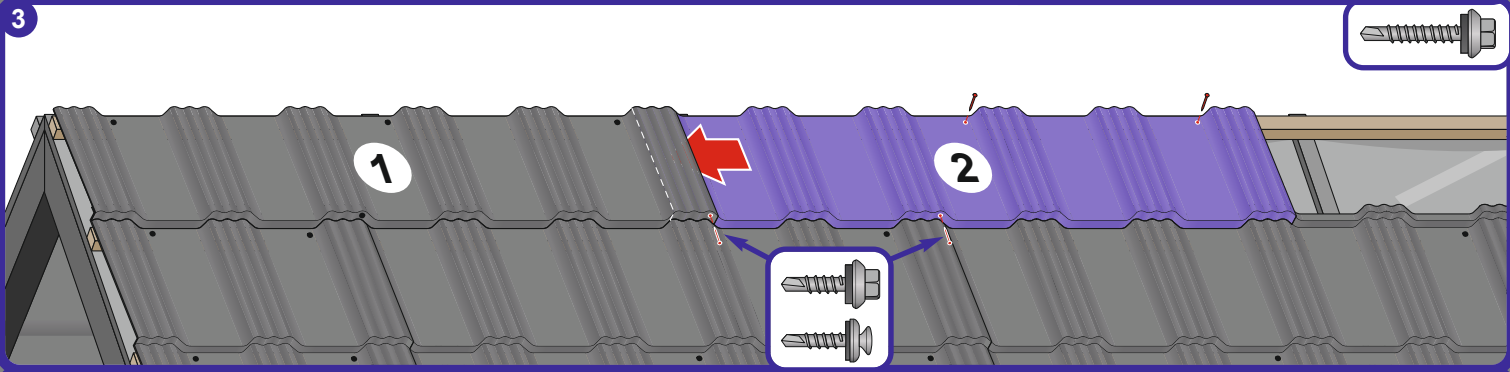
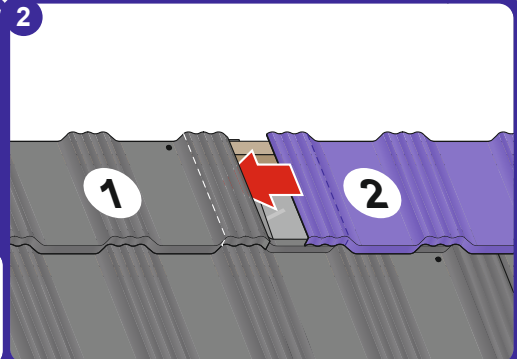
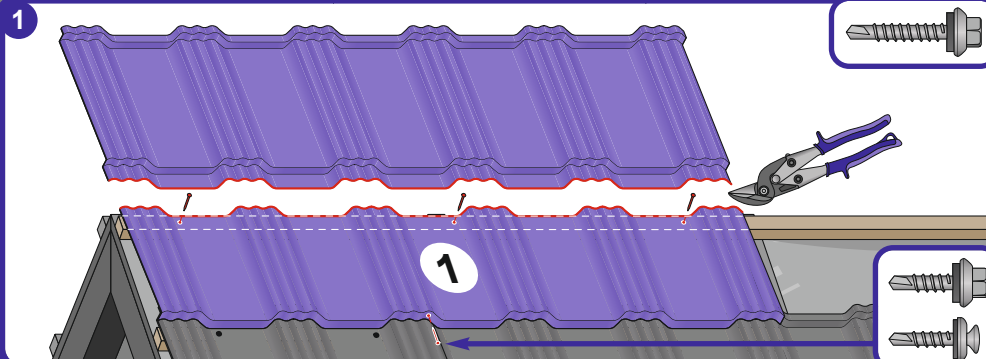
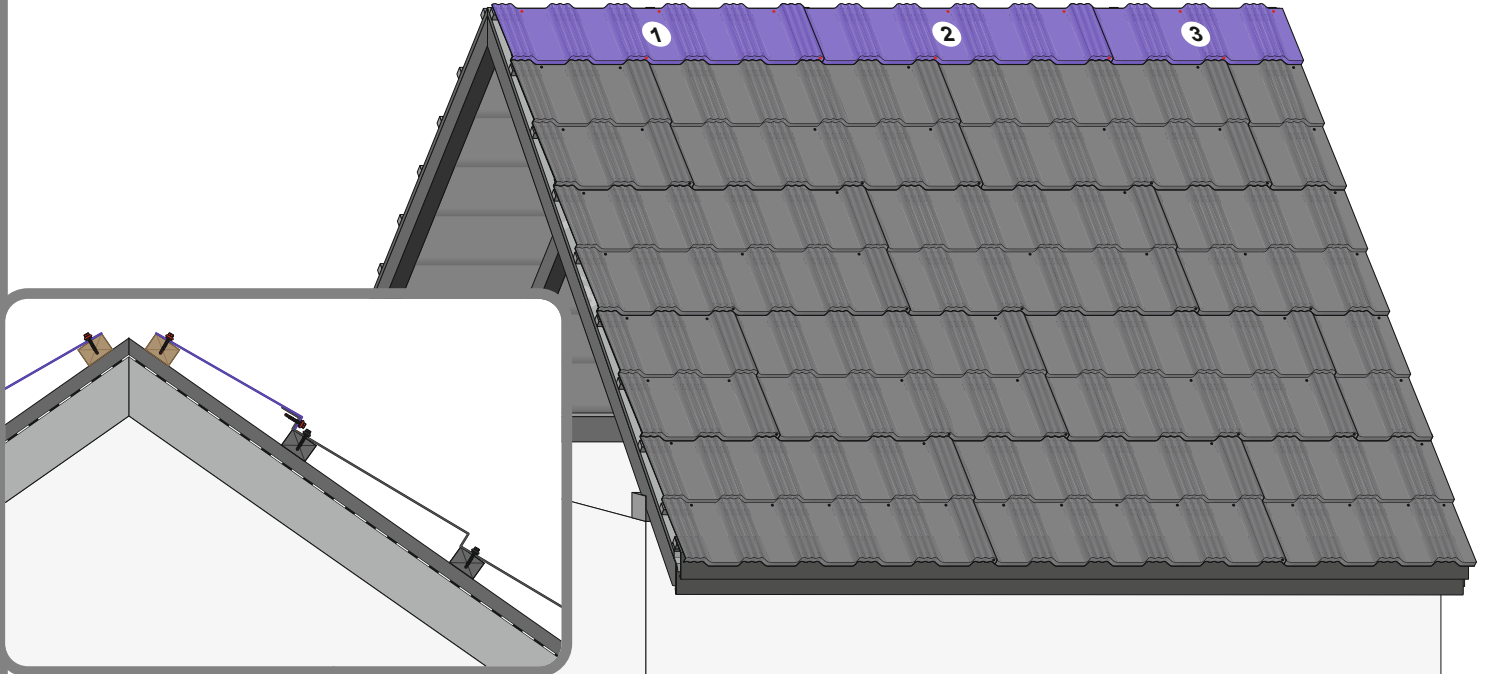
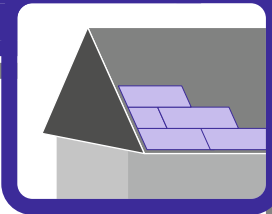

5d

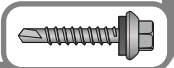
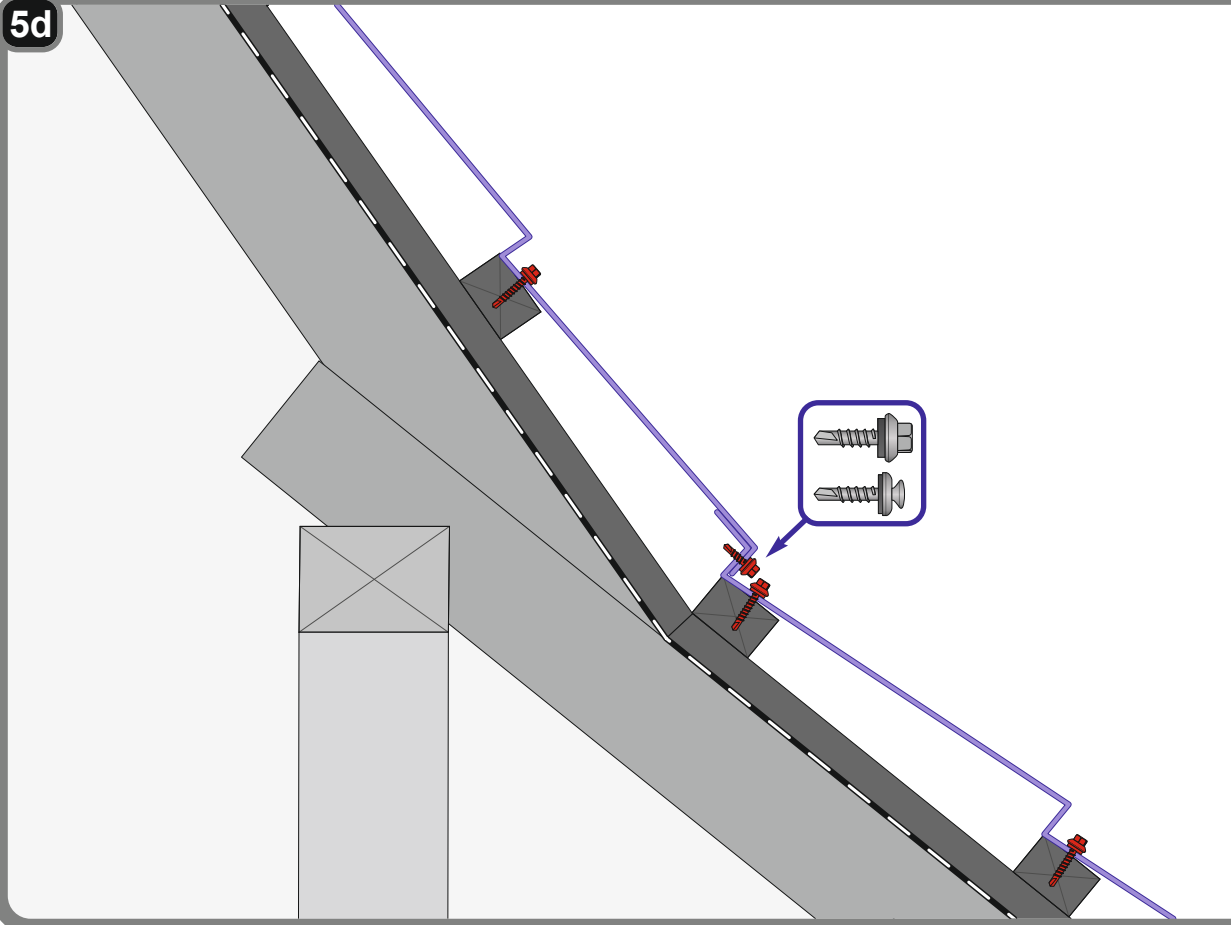
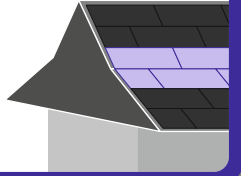

5e

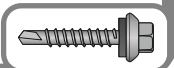
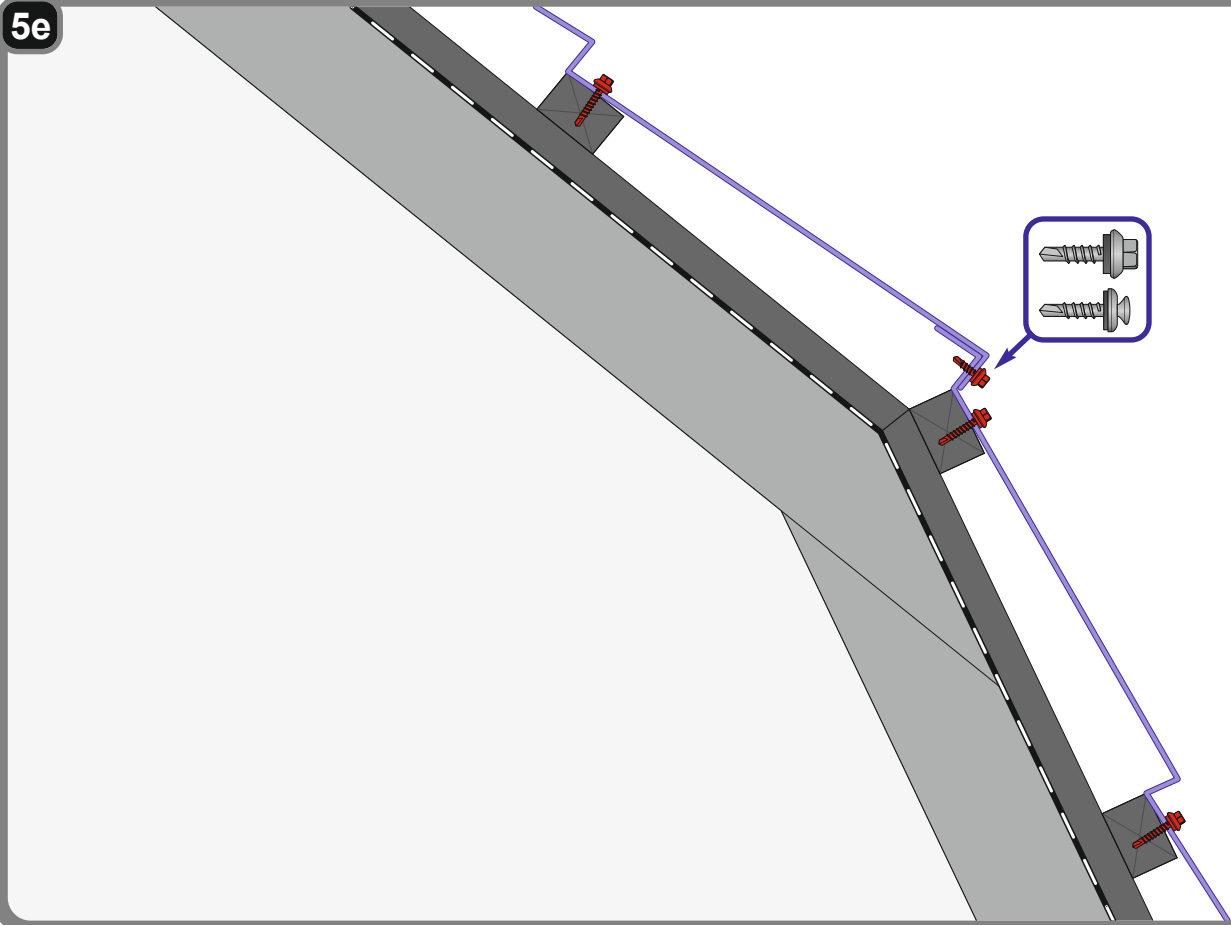
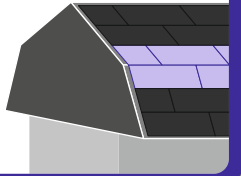

6a

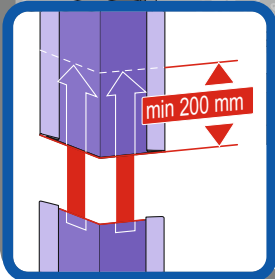
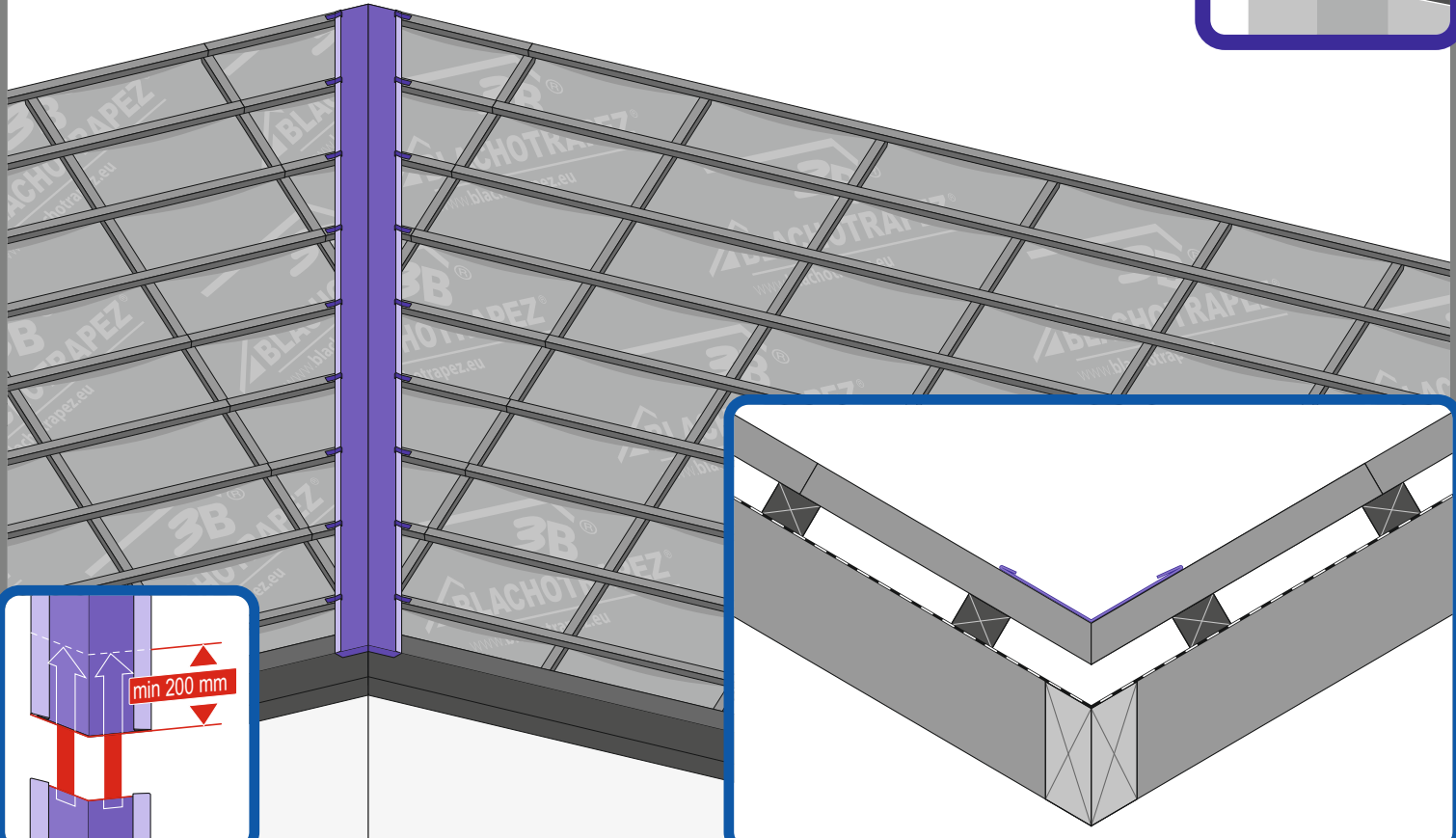
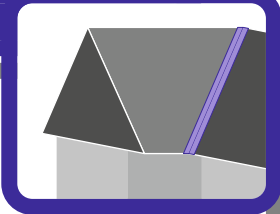

6b

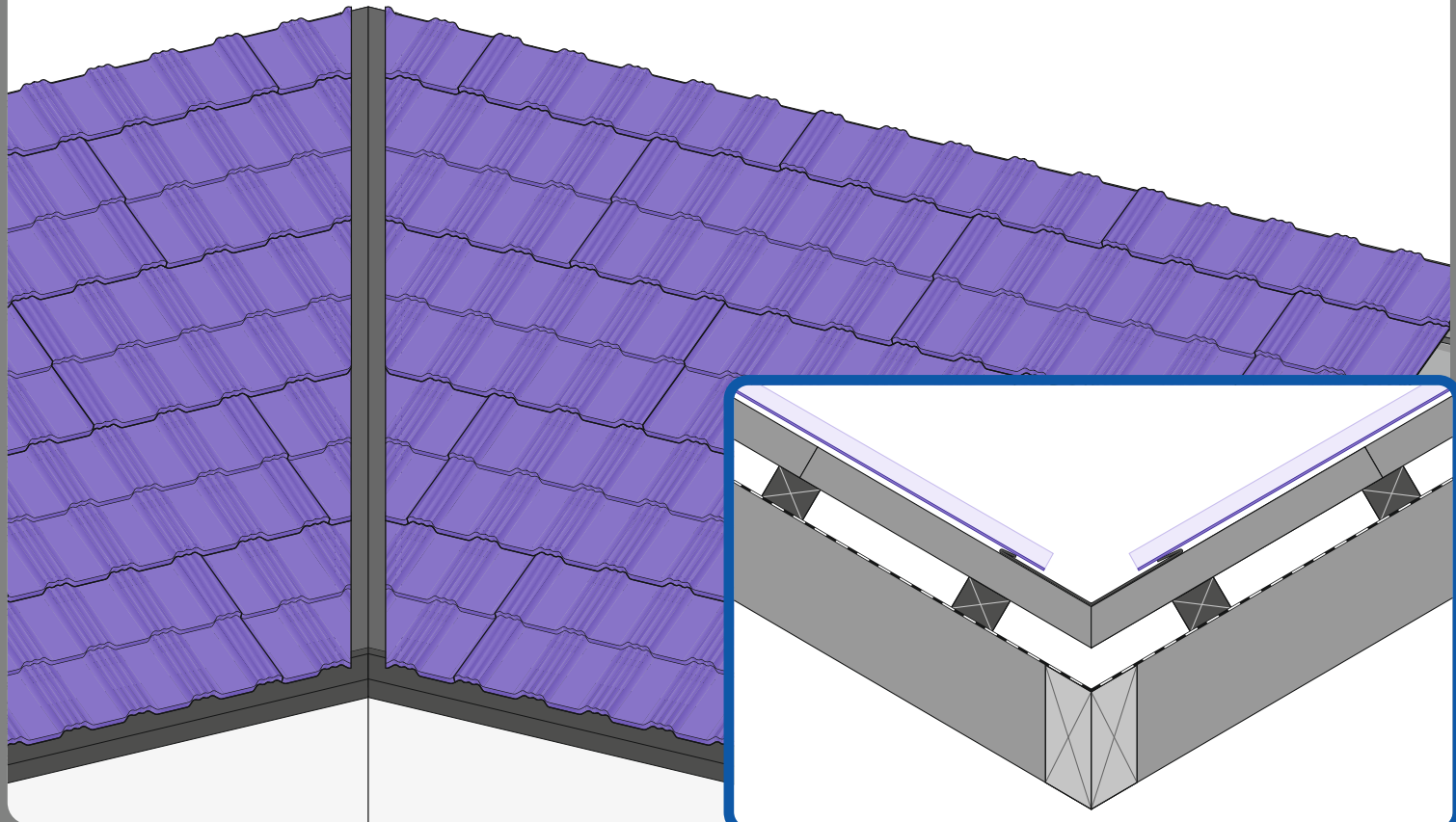

**Germania**<sup>®</sup>  
simetric

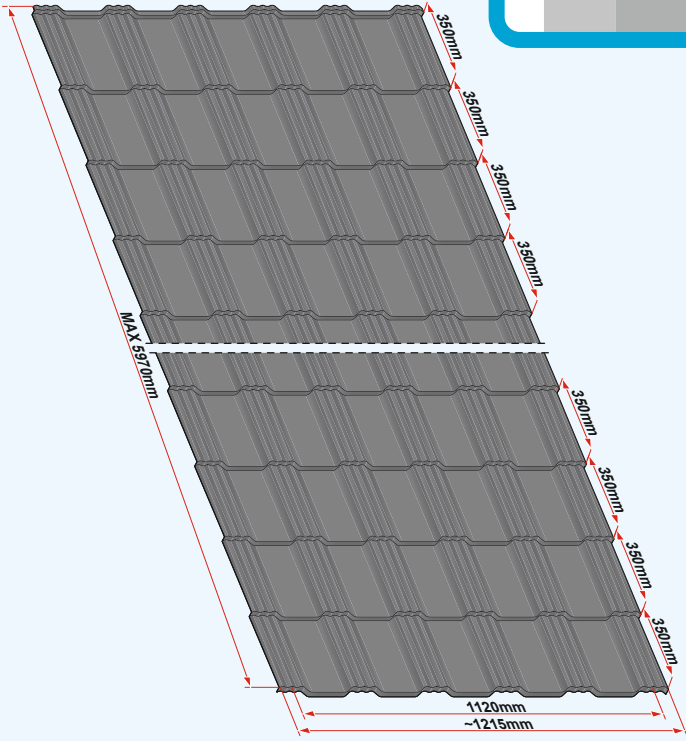
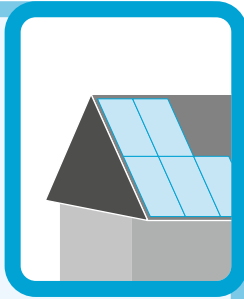

**GERMAN**  
simetric

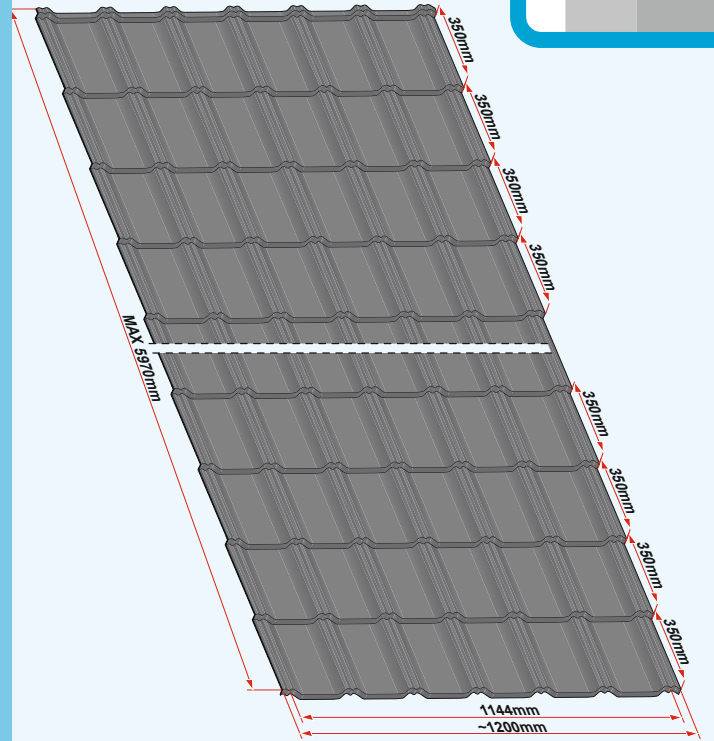
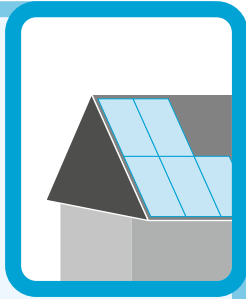

**TANIA**

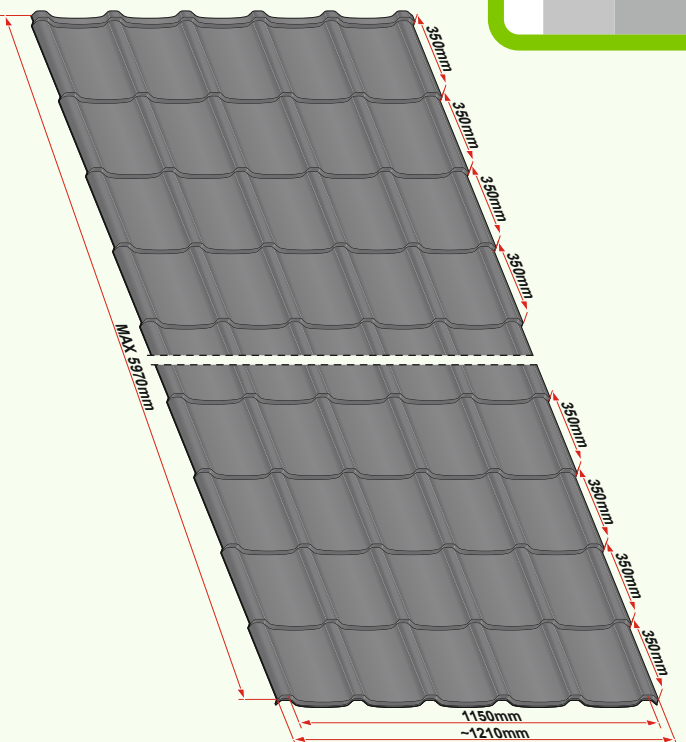
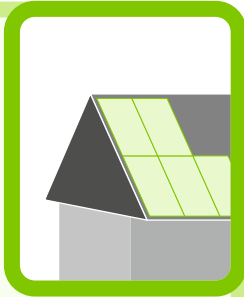

**ENIGMA**

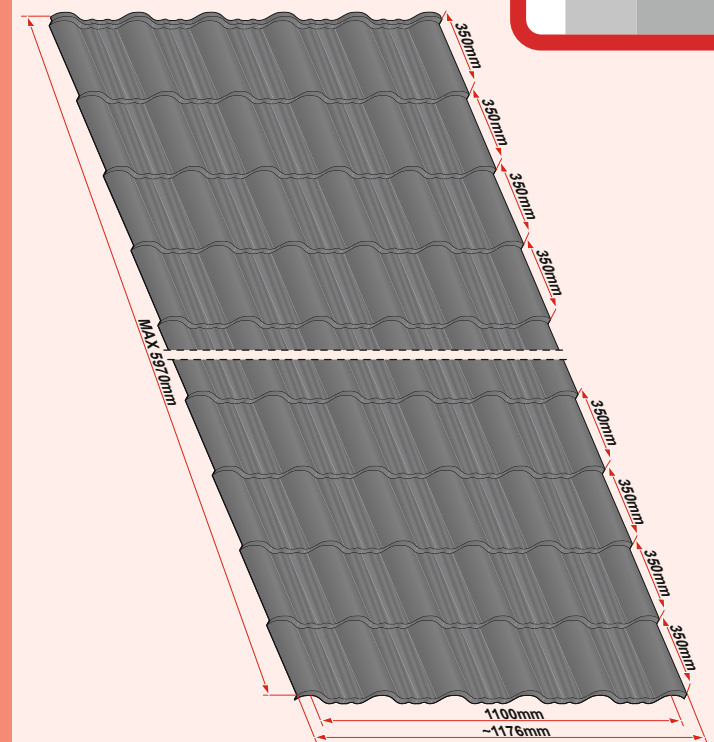
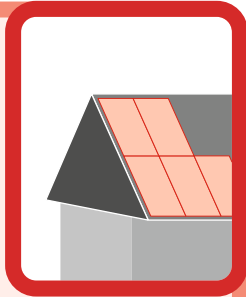

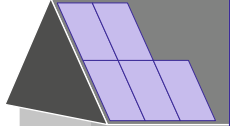

7a

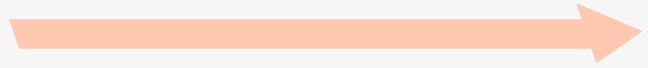
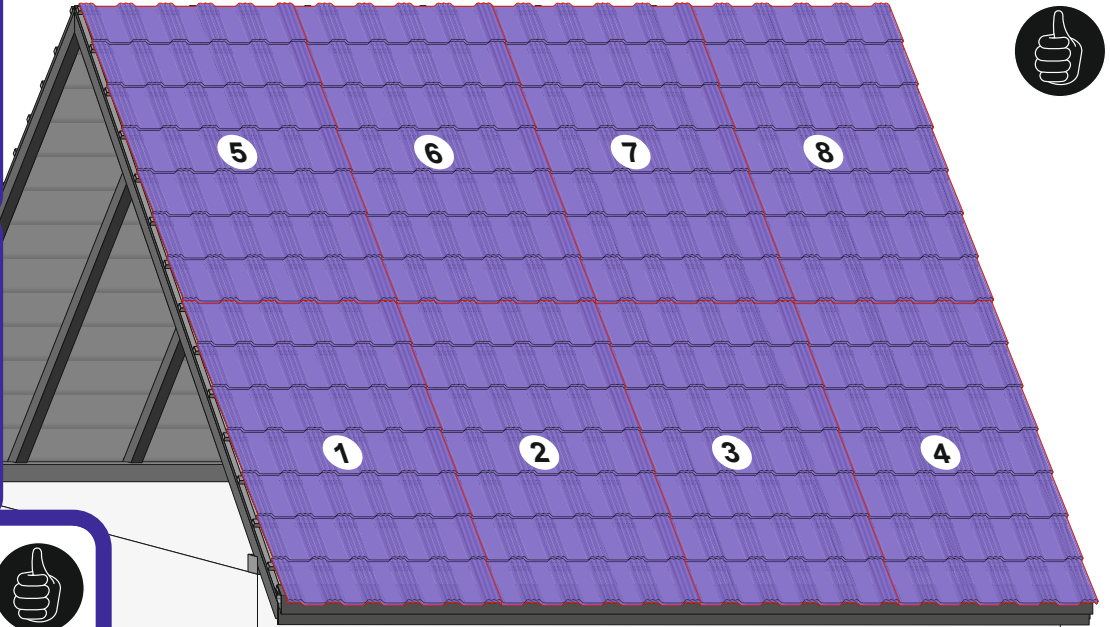
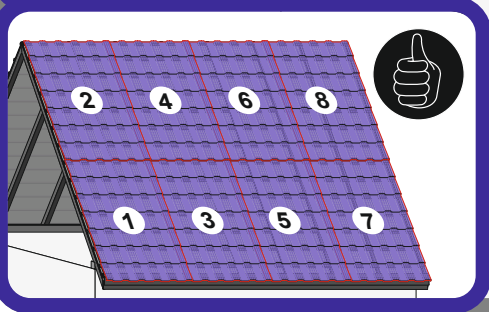
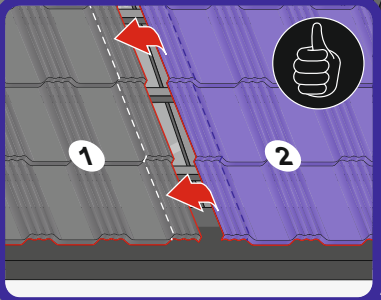
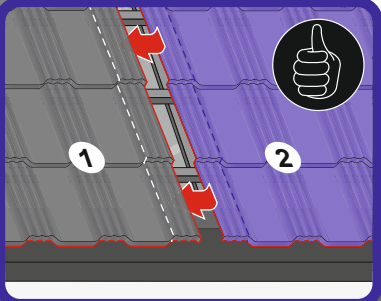

7b

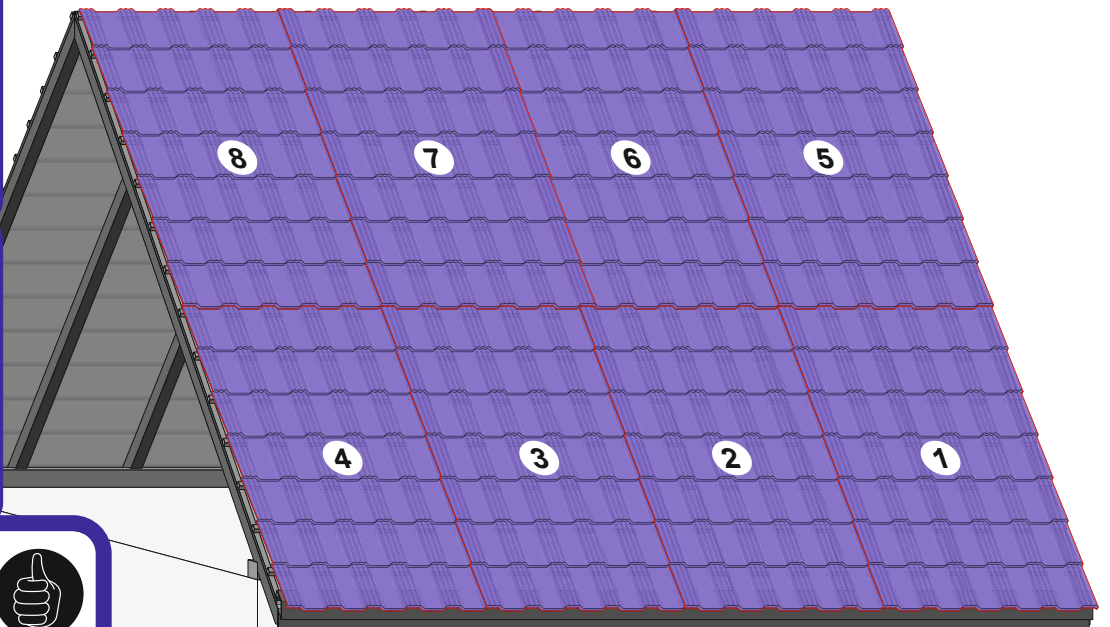
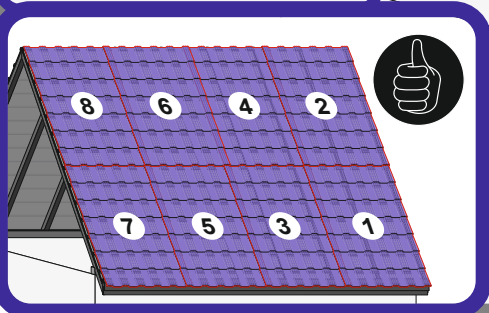
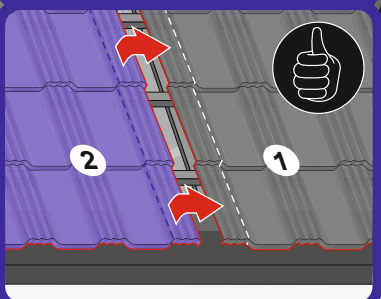
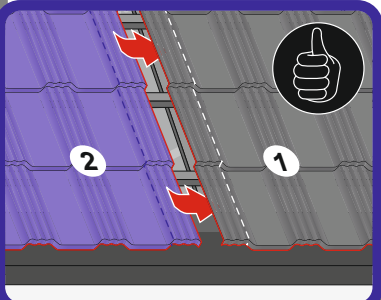

8a

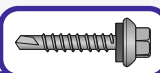
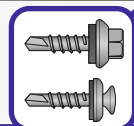
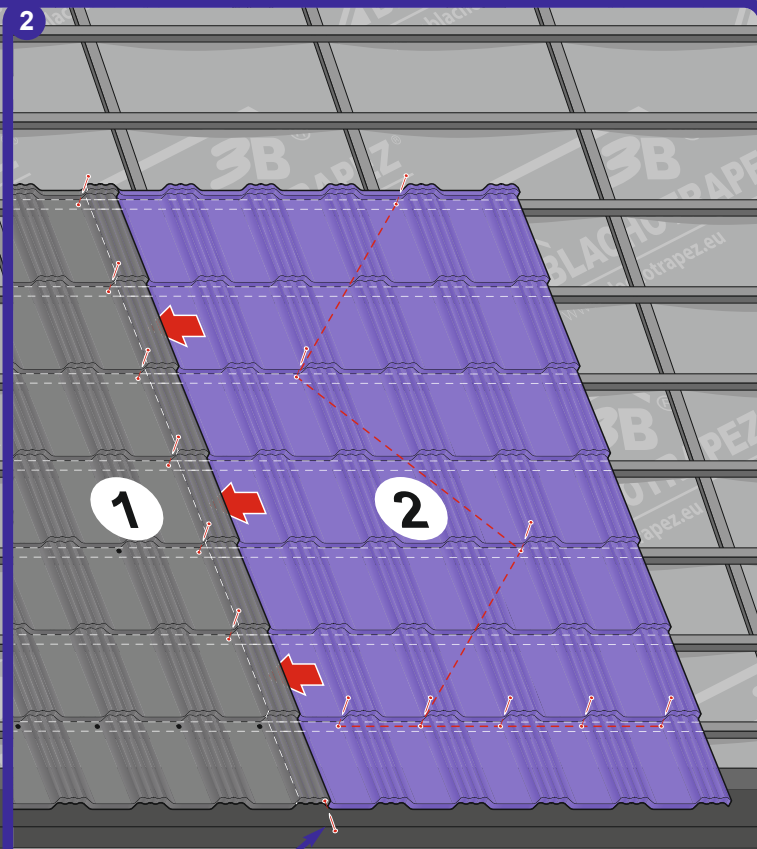
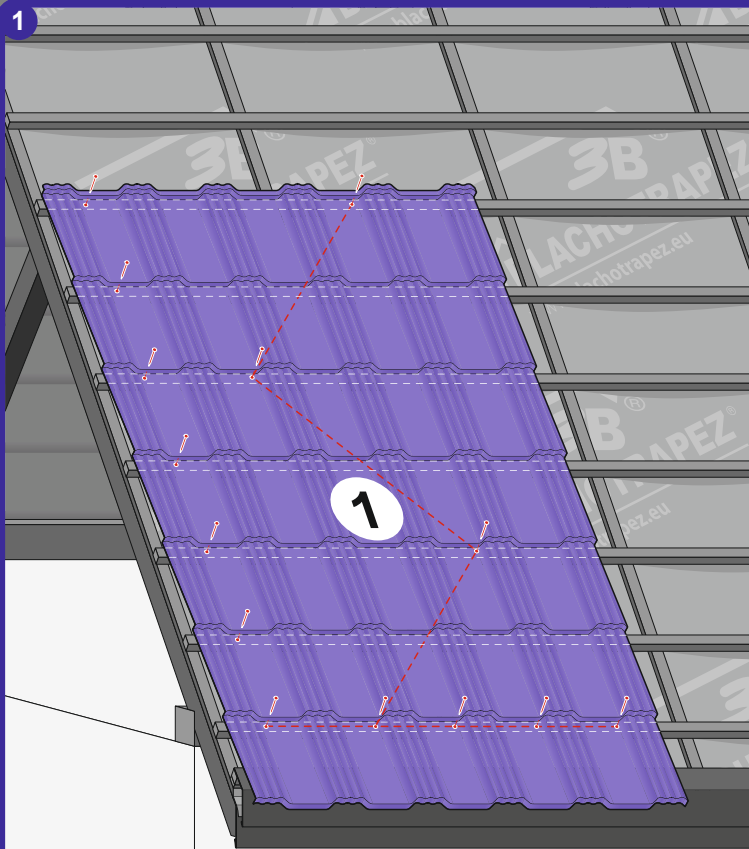
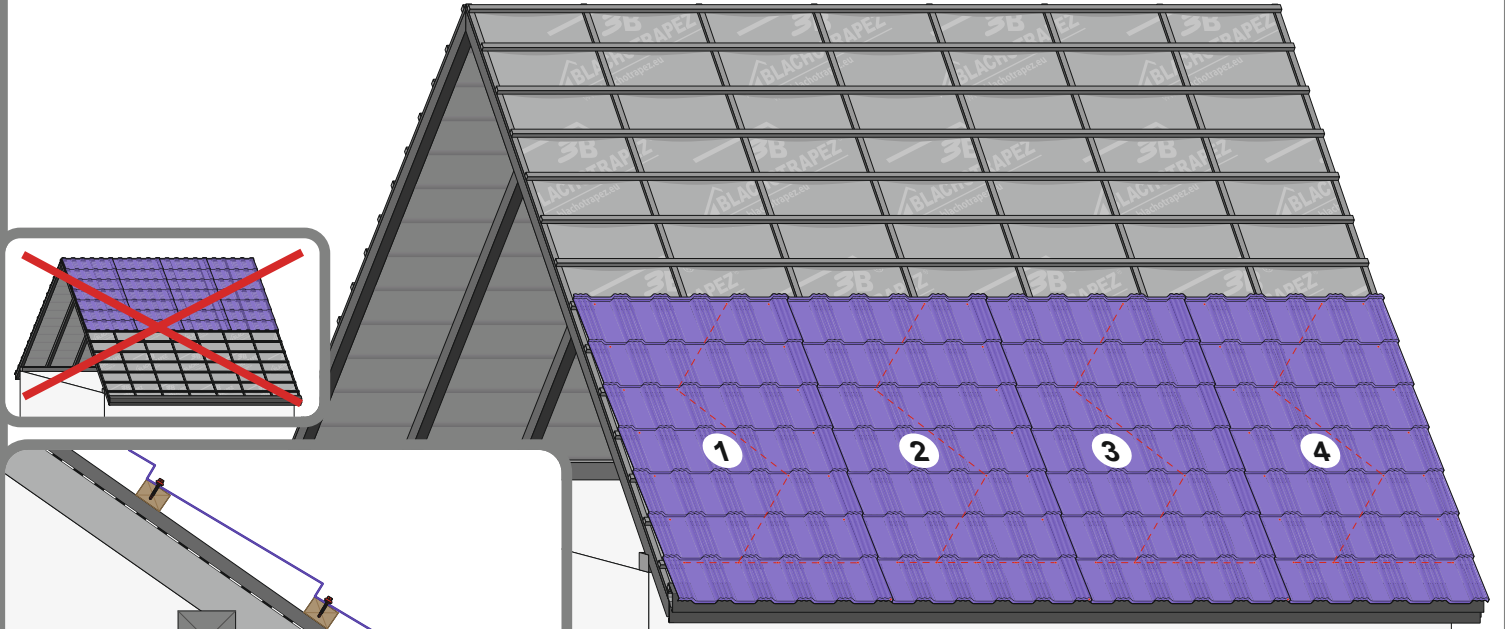
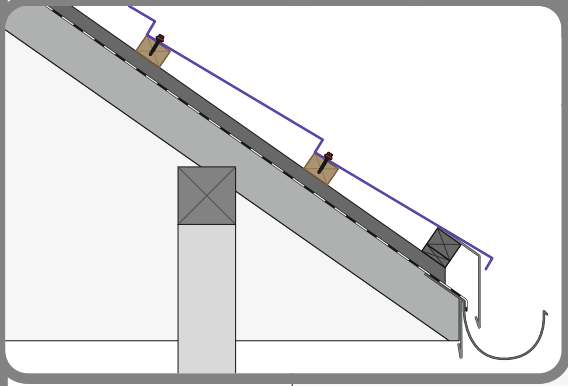
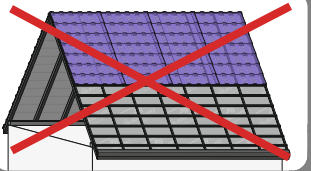
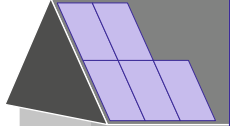



8b

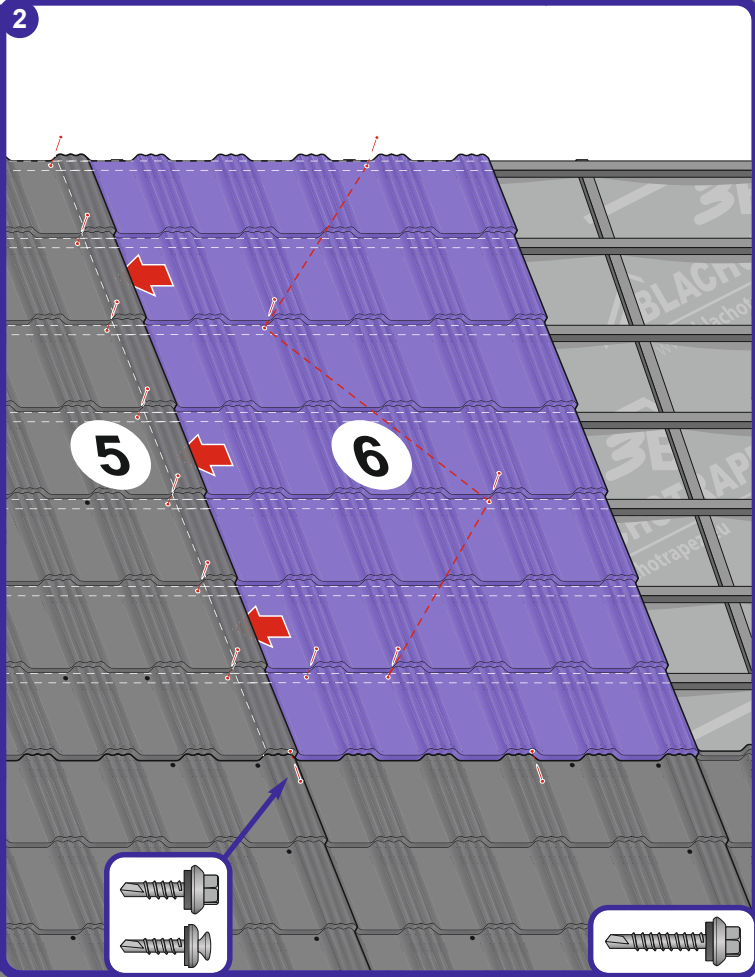
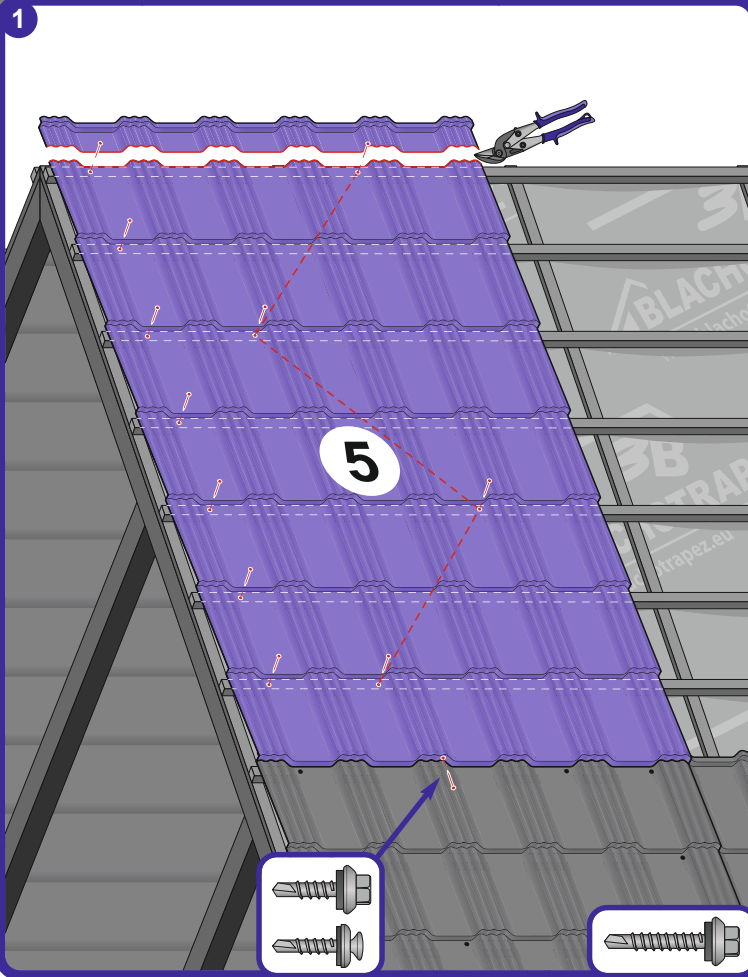
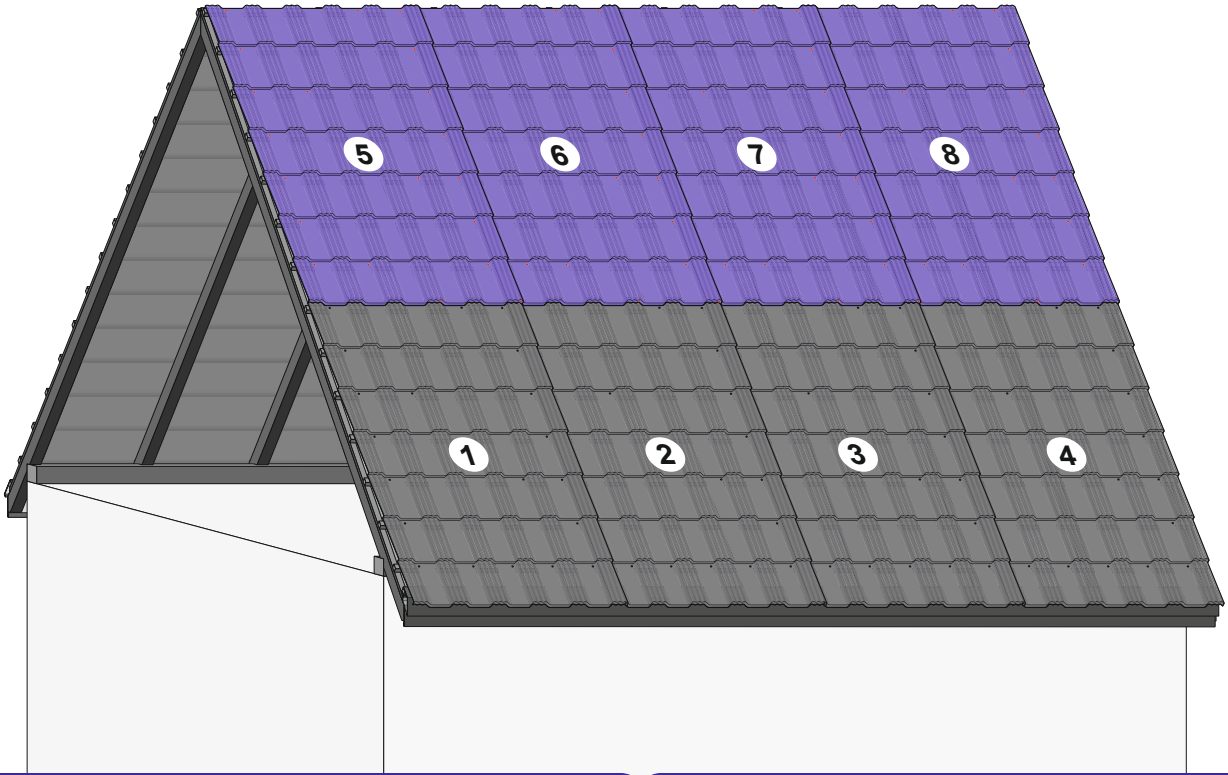
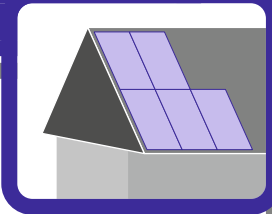

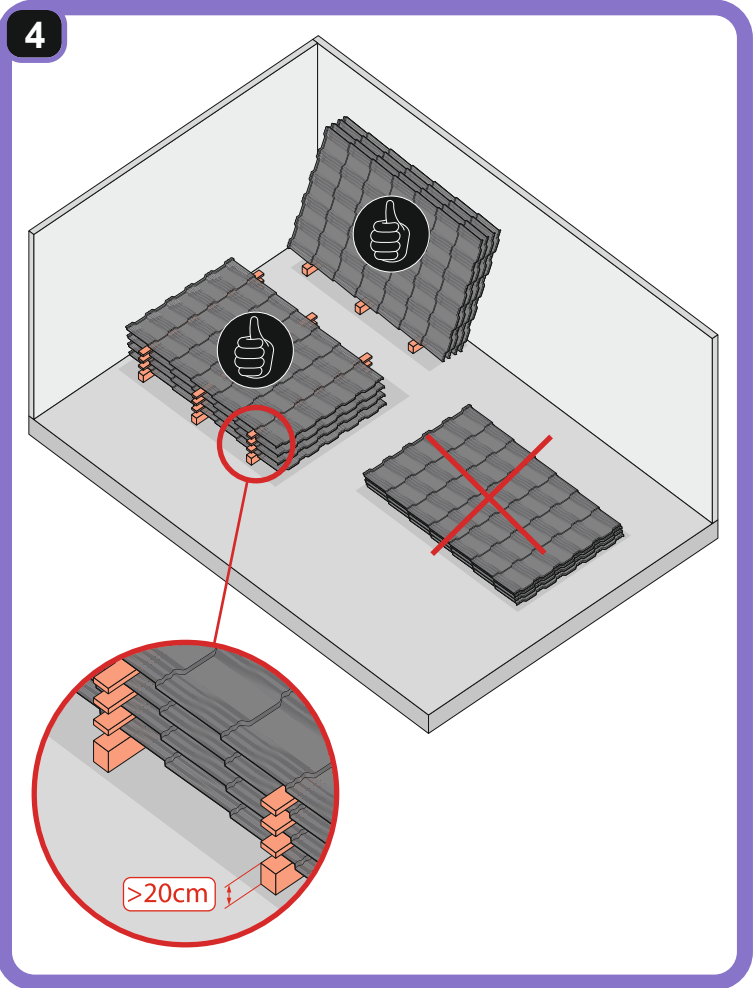
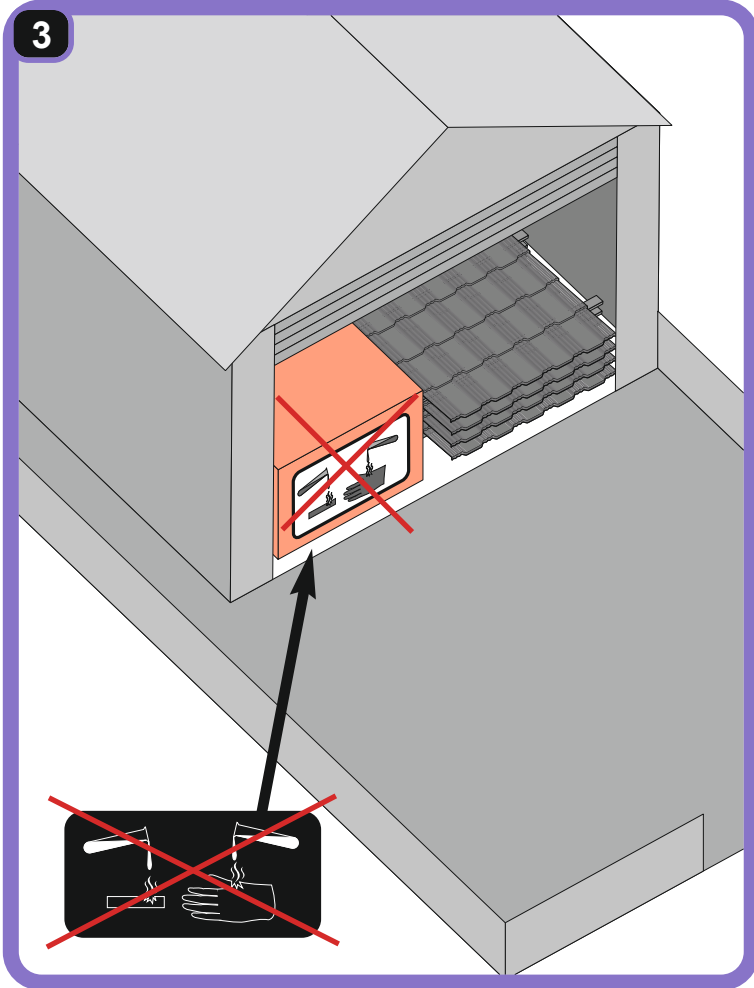
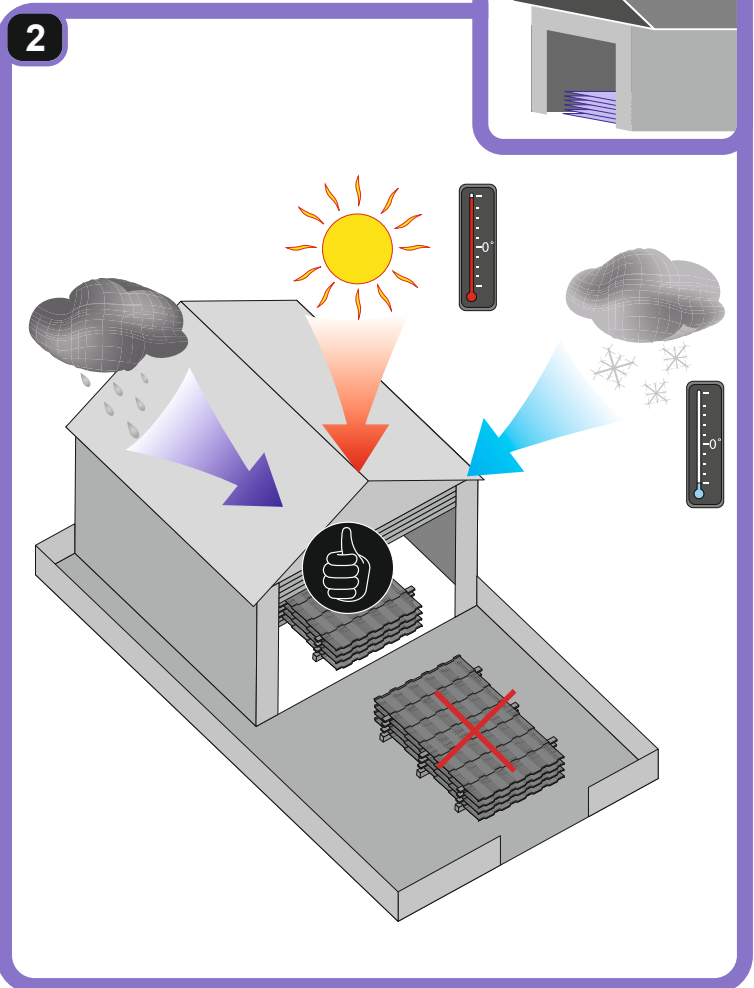
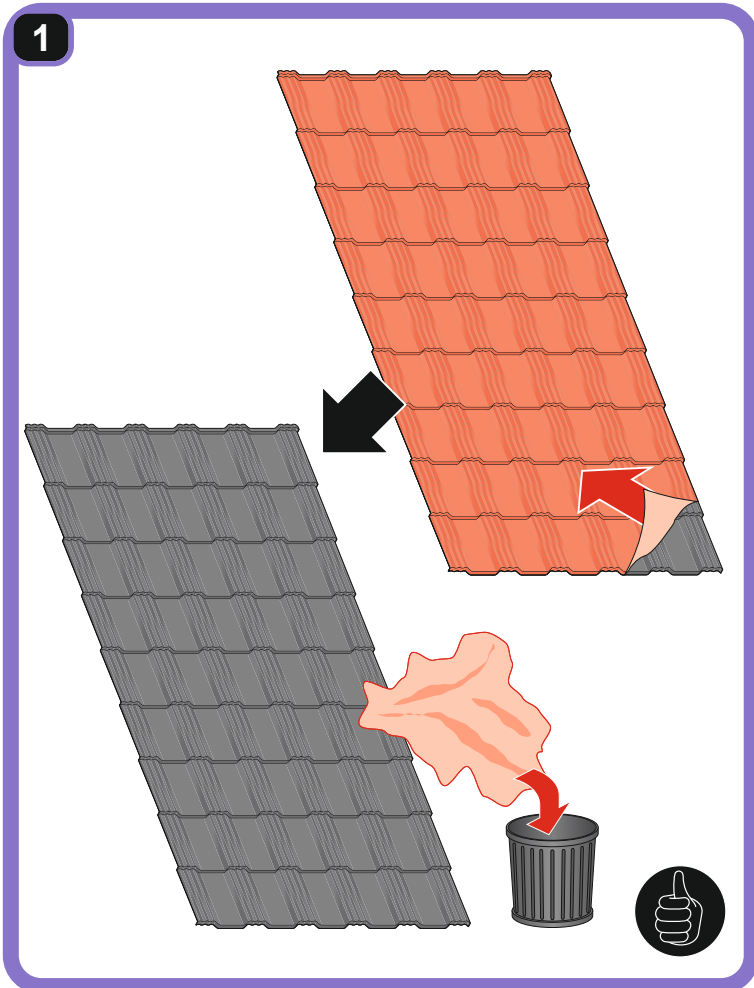

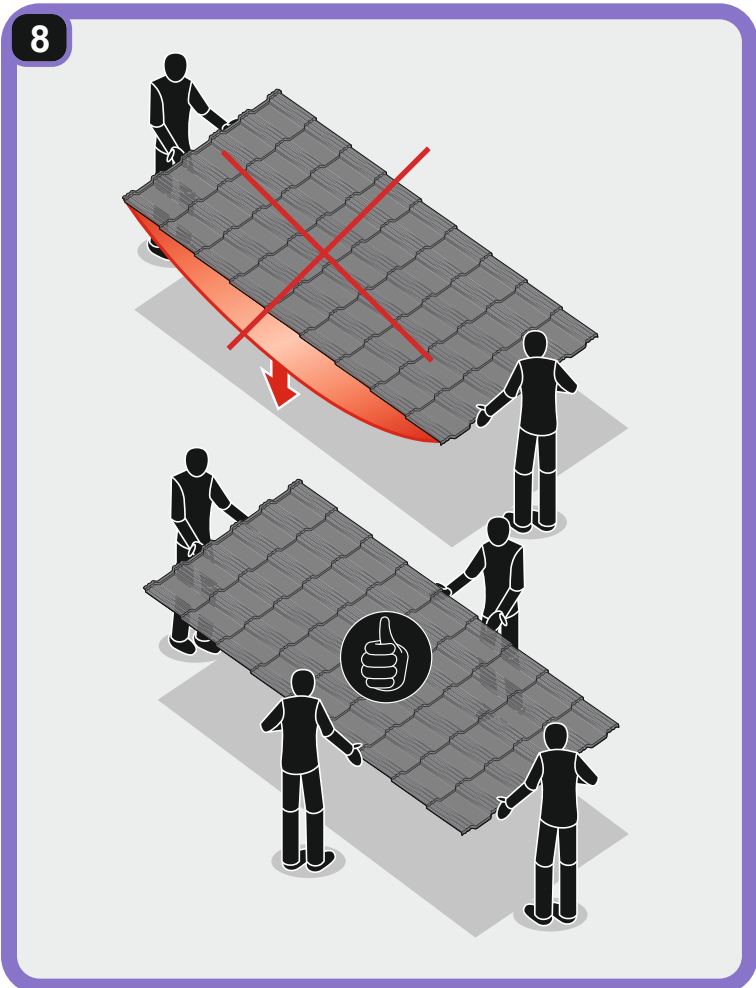
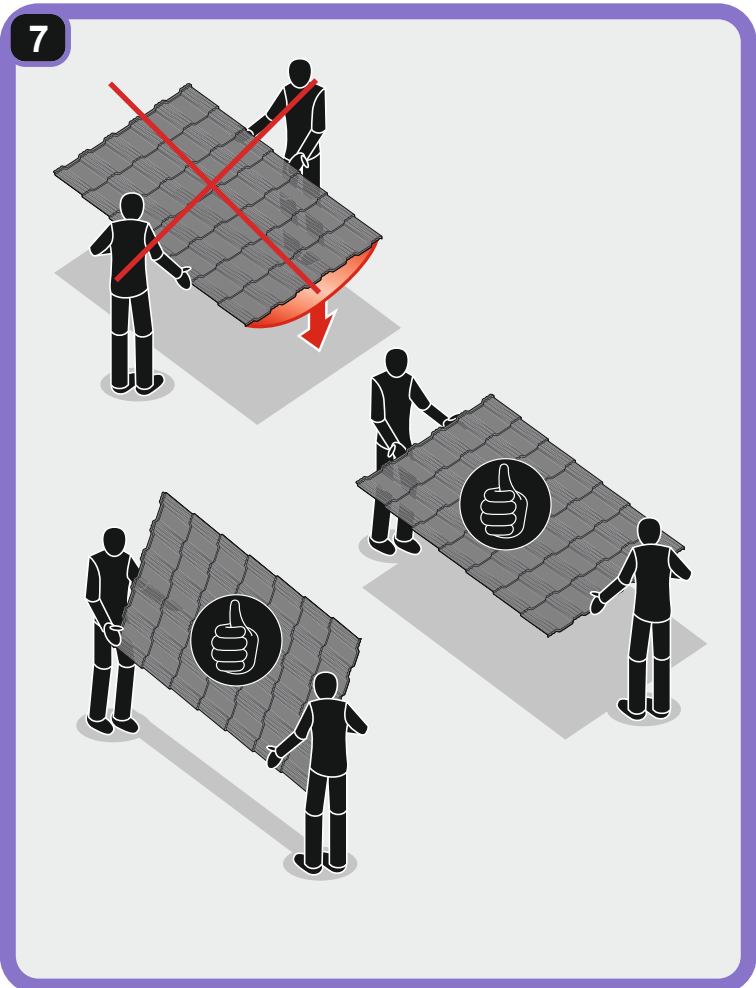
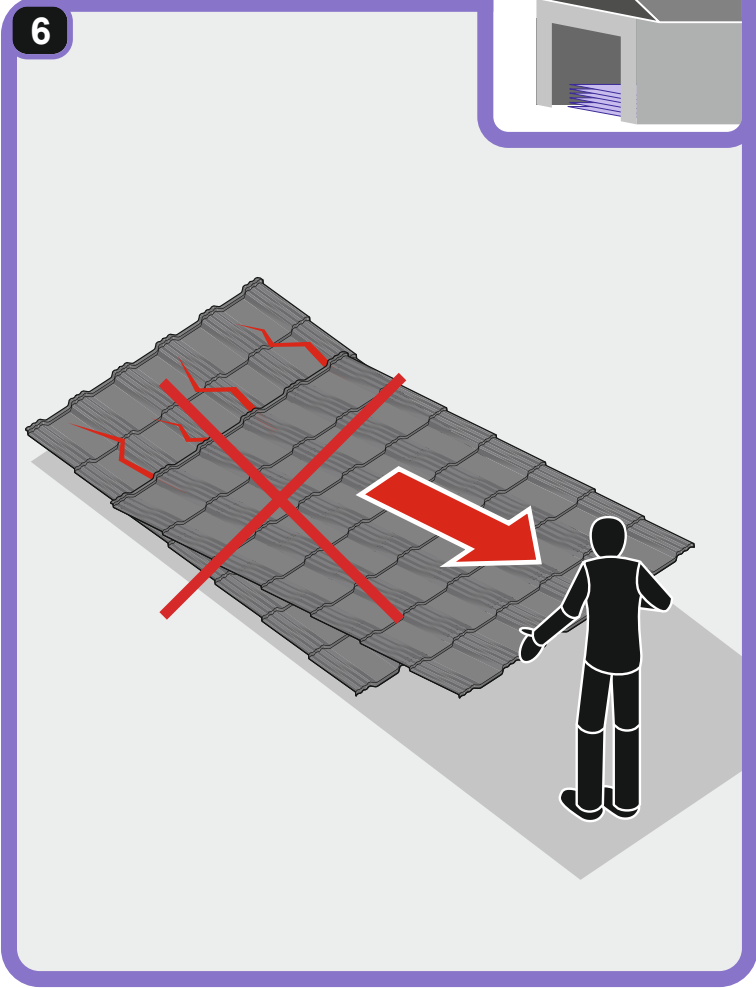
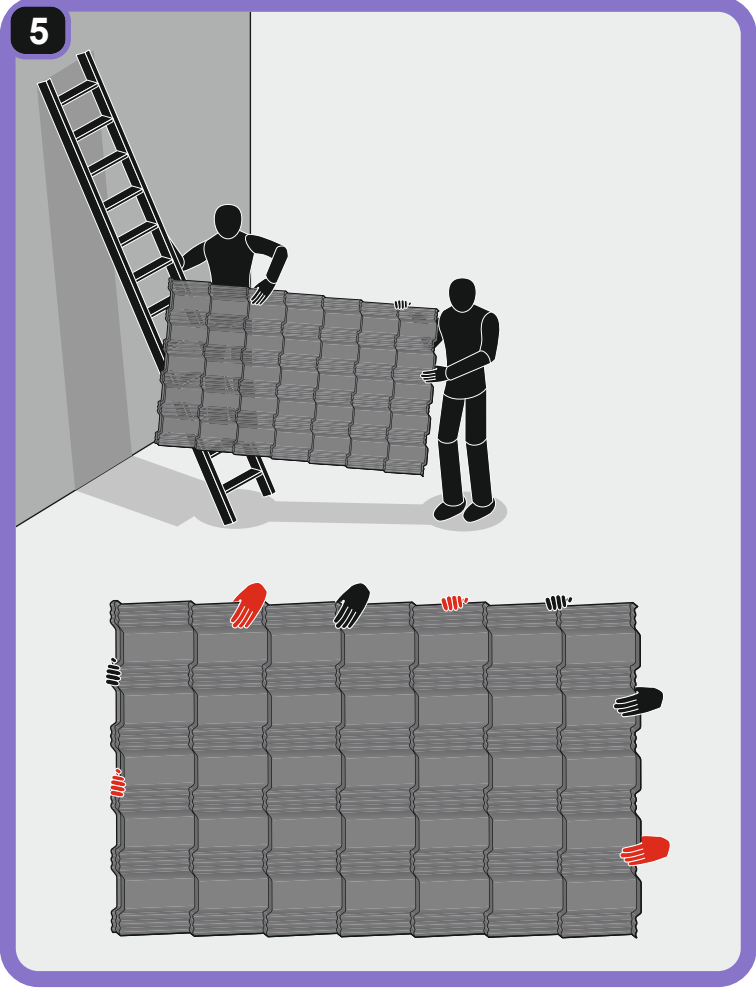
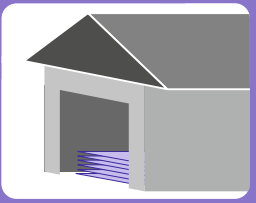

## Přehled sortimentu



Dutinkové desky  
Twinwall sheets



Vlnité desky  
Profile plates



Vchodové stříšky  
Canopies

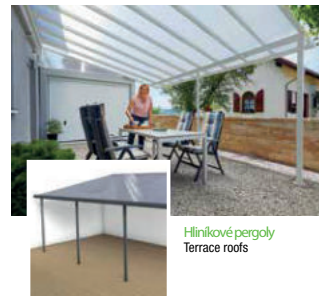

Hliníkové pergoly  
Terrace roofs



Polykarbonátové panely  
Twinwall panels



Polystyrolové desky  
Polystyrene sheets



Bitumenové desky  
Corrugated bitumen sheets



Nopové fólie  
Dimpled Membrane

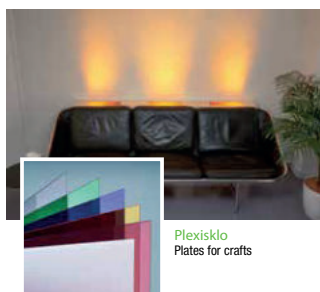

Plexisklo  
Plates for crafts



Zatrávňovací tvárnice  
Lawn grids

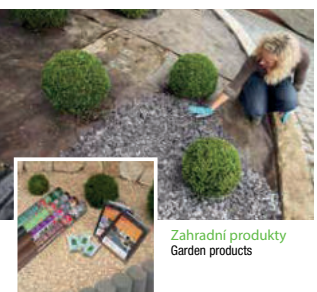

Zahradní produkty  
Garden products

... a mnohem více !

Montáž střešních plechů vyžaduje odborné znalosti a zkušenosti. Tento návod je ilustrativní a nezbavuje dodavatele povinnosti dodržovat pravidla pokrývačské praxe a norem. Způsoby montáže uvedené v tomto návodu slouží jako obecné pokyny. Požadovaný způsob montáže se může lišit od toho, který je uveden v návodu v závislosti na typu střechy nebo regionálním řešení. Pro obecné pokyny a tipy pro instalaci postupujte podle pokynů projektanta nebo kontaktujte naše oddělení technické podpory.

